

Think Java

How to Think Like a Computer Scientist

2nd Edition, Version 7.0.0 DRAFT

Think Java

How to Think Like a Computer Scientist

2nd Edition, Version 7.0.0 DRAFT

Allen B. Downey and Chris Mayfield

Green Tea Press

Needham, Massachusetts

Copyright © 2019 Allen B. Downey and Chris Mayfield.

Green Tea Press
9 Washburn Ave
Needham, MA 02492

Permission is granted to copy, distribute, and/or modify this work under the terms of the Creative Commons Attribution-NonCommercial-ShareAlike 4.0 International License, which is available at <https://creativecommons.org/licenses/by-nc-sa/4.0/>.

The original form of this book is L^AT_EX source code. Compiling this code has the effect of generating a device-independent representation of the book, which can be converted to other formats and printed.

The L^AT_EX source for this book is available from <https://thinkjava.org/> and <https://github.com/ChrisMayfield/ThinkJava2>.

Contents

Preface	xv
1 Computer Programming	1
1.1 What Is a Computer?	1
1.2 What Is Programming?	2
1.3 The Hello World Program	3
1.4 Compiling Java Programs	5
1.5 Displaying Two Messages	6
1.6 Formatting Source Code	7
1.7 Escape Sequences	9
1.8 What Is Computer Science?	10
1.9 Debugging Programs	11
1.10 Vocabulary	12
1.11 Exercises	14
2 Variables and Operators	17
2.1 Declaring Variables	17
2.2 Assigning Variables	18
2.3 Memory Diagrams	19
2.4 Printing Variables	21

2.5	Arithmetic Operators	22
2.6	Floating-Point Numbers	23
2.7	Rounding Errors	24
2.8	Operators for Strings	25
2.9	Compiler Error Messages	27
2.10	Other Types of Errors	28
2.11	Vocabulary	29
2.12	Exercises	31
3	Input and Output	33
3.1	The System Class	33
3.2	The Scanner Class	34
3.3	Language Elements	36
3.4	Literals and Constants	37
3.5	Formatting Output	39
3.6	Reading Error Messages	40
3.7	Type Cast Operators	41
3.8	Remainder Operator	42
3.9	Putting It All Together	43
3.10	The Scanner Bug	45
3.11	Vocabulary	46
3.12	Exercises	47
4	Methods and Testing	51
4.1	Defining New Methods	51
4.2	Flow of Execution	53
4.3	Parameters and Arguments	54

4.4	Multiple Parameters	55
4.5	Stack Diagrams	57
4.6	Math Methods	58
4.7	Composition	59
4.8	Return Values	60
4.9	Incremental Development	62
4.10	Vocabulary	64
4.11	Exercises	66
5	Conditionals and Logic	71
5.1	Relational Operators	71
5.2	The if-else Statement	72
5.3	Chaining and Nesting	74
5.4	The switch Statement	75
5.5	Logical Operators	77
5.6	De Morgan's Laws	78
5.7	Boolean Variables	79
5.8	Boolean Methods	80
5.9	Validating Input	81
5.10	Example Program	83
5.11	Vocabulary	84
5.12	Exercises	85
6	Loops and Strings	89
6.1	The while Statement	89
6.2	Increment and Decrement	91
6.3	The for Statement	92

6.4	Nested Loops	94
6.5	Characters	95
6.6	Which Loop to Use	96
6.7	String Iteration	97
6.8	The indexOf Method	98
6.9	Substrings	99
6.10	String Comparison	100
6.11	String Formatting	101
6.12	Vocabulary	102
6.13	Exercises	103
7	Arrays and References	107
7.1	Creating Arrays	108
7.2	Accessing Elements	109
7.3	Displaying Arrays	110
7.4	Copying Arrays	111
7.5	Array Traversal	113
7.6	Random Numbers	115
7.7	Building a Histogram	116
7.8	The Enhanced for Loop	118
7.9	Counting Characters	119
7.10	Vocabulary	121
7.11	Exercises	122
8	Recursive Methods	127
8.1	Recursive Void Methods	127
8.2	Recursive Stack Diagrams	129

8.3	Value-Returning Methods	130
8.4	The Leap of Faith	133
8.5	Counting Up Recursively	135
8.6	Binary Number System	135
8.7	Recursive Binary Method	137
8.8	CodingBat Problems	138
8.9	Vocabulary	140
8.10	Exercises	141
9	Immutable Objects	147
9.1	Primitives vs Objects	147
9.2	The null Keyword	149
9.3	Strings are Immutable	150
9.4	Wrapper Classes	151
9.5	Command-Line Arguments	152
9.6	Argument Validation	154
9.7	BigInteger Arithmetic	156
9.8	Incremental Design	157
9.9	More Generalization	159
9.10	Vocabulary	160
9.11	Exercises	161
10	Mutable Objects	167
10.1	Point Objects	167
10.2	Objects as Parameters	169
10.3	Objects as Return Values	170
10.4	Rectangles are Mutable	171

10.5	Aliasing Revisited	172
10.6	Java Library Source	173
10.7	Class Diagrams	174
10.8	Scope Revisited	175
10.9	Garbage Collection	176
10.10	Mutable vs Immutable	177
10.11	StringBuilder Objects	178
10.12	Vocabulary	179
10.13	Exercises	180
11	Designing Classes	183
11.1	The Time Class	184
11.2	Constructors	185
11.3	More Constructors	186
11.4	Getters and Setters	188
11.5	Displaying Objects	190
11.6	The toString Method	191
11.7	The equals Method	192
11.8	Adding Times	194
11.9	Vocabulary	196
11.10	Exercises	197
12	Arrays of Objects	201
12.1	Card Objects	202
12.2	Card toString	203
12.3	Class Variables	205
12.4	The compareTo Method	206

12.5	Cards are Immutable	207
12.6	Arrays of Cards	208
12.7	Sequential Search	210
12.8	Binary Search	211
12.9	Tracing the Code	213
12.10	Vocabulary	214
12.11	Exercises	214
13	Objects of Arrays	217
13.1	Decks of Cards	217
13.2	Shuffling Decks	219
13.3	Selection Sort	220
13.4	Merge Sort	221
13.5	Subdecks	222
13.6	Merging Decks	223
13.7	Adding Recursion	224
13.8	Static Context	225
13.9	Piles of Cards	227
13.10	Playing War	229
13.11	Vocabulary	231
13.12	Exercises	231
14	Extending Classes	235
14.1	CardCollection	236
14.2	Inheritance	238
14.3	Dealing Cards	240
14.4	The Player Class	242

14.5	The Eights Class	244
14.6	Class Relationships	247
14.7	Vocabulary	248
14.8	Exercises	249
A	Tools	251
A.1	Installing DrJava	251
A.2	DrJava Interactions	253
A.3	Command-Line Interface	254
A.4	Command-Line Testing	255
A.5	Running Checkstyle	257
A.6	Tracing with a Debugger	258
A.7	Testing with JUnit	259
A.8	Vocabulary	261
B	Javadoc	263
B.1	Reading Documentation	264
B.2	Writing Documentation	266
B.3	Javadoc Tags	267
B.4	Example Source File	269
B.5	Vocabulary	272
C	Graphics	273
C.1	Creating Graphics	273
C.2	Graphics Methods	274
C.3	Example Drawing	276
C.4	Vocabulary	278

C.5	Exercises	278
D	Debugging	281
D.1	Compile-Time Errors	281
D.2	Run-Time Errors	285
D.3	Logic Errors	289
E	Extras	295
E.1	Unreachable Code	295
E.2	Method Composition	297
E.3	Overloading Methods	298
E.4	Generating Tables	299
E.5	The do-while Loop	301
E.6	Break and Continue	302
E.7	Modifier Methods	303
E.8	Recursive Search	304
Index		307

Preface

Think Java is an introduction to computer science and programming intended for readers with little or no experience. We start with the most basic concepts and are careful to define all terms when they are first used. The book presents each new idea in a logical progression. Larger topics, like control flow statements and object-oriented programming, are divided into smaller examples and introduced over the course of several chapters.

This book is intentionally concise. Each chapter is 12–14 pages and covers the material for one week of a college course. It is not meant to be a comprehensive presentation of Java, but rather, an initial exposure to programming constructs and techniques. We begin with small problems and basic algorithms and work up to object-oriented design. In the vocabulary of computer science pedagogy, this book uses the “objects late” approach.

The Philosophy Behind the Book

Here are the guiding principles that make the book the way it is:

- *One concept at a time.* We break down topics that give beginners trouble into a series of small steps, so that they can exercise each new concept in isolation before continuing.
- *Balance of Java and concepts.* The book is not primarily about Java; it uses code examples to demonstrate computer science. Most chapters start with language features and end with concepts.

- *Conciseness.* An important goal of the book is to be small enough so that students can read and understand the entire text in a one-semester college or AP course.
- *Emphasis on vocabulary.* We try to introduce the minimum number of terms and define them carefully when they are first used. We also organize them in glossaries at the end of each chapter.
- *Program development.* There are many strategies for writing programs, including bottom-up, top-down, and others. We demonstrate multiple program development techniques, allowing readers to choose methods that work best for them.
- *Multiple learning curves.* To write a program, you have to understand the algorithm, know the programming language, and be able to debug errors. We discuss these and other aspects throughout the book, and include an appendix that summarizes our advice.

Object-Oriented Programming

Some Java books introduce classes and objects immediately; others begin with procedural programming and transition to object-oriented more gradually.

Many of Java's object-oriented features are motivated by problems with previous languages, and their implementations are influenced by this history. Some of these features are hard to explain when people aren't familiar with the problems they solve.

We get to object-oriented programming as quickly as possible (beginning with Chapter 9). But we introduce concepts one at a time, as clearly as possible, in a way that allows readers to practice each idea in isolation before moving on. So it takes some time to get there.

You can't write Java programs (even hello world) without encountering object-oriented features. In some cases we explain a feature briefly when it first appears, and then explain it more deeply later on.

This book is well suited to prepare students for the AP Computer Science A exam, which includes object-oriented design and implementation. (AP is

a registered trademark of the College Board.) We introduce nearly every topic in the “AP Java subset” with a few exceptions. A mapping of *Think Java* section numbers to the current AP course description is available on our website: <https://thinkjava.org/>.

Changes to the 2nd Edition

This new edition was written over several years, with feedback from dozens of instructors and hundreds of students. A complete history of all changes is available on GitHub. Here are some of the highlights:

Chapters 1–4: We reordered the material in Chapter 1 to present a more interesting balance of theory and practice. Chapters 2–3 are much cleaner now too. Methods are now presented in a single chapter, along with additional in-depth examples.

Chapters 5–8: We rearranged these chapters a lot, added many examples and new figures, and removed unnecessary details. Strings are covered earlier (before arrays) so that readers can apply them to loop problems. The material on recursion is now a chapter, and we added new sections to explain binary numbers and CodingBat problems.

Chapters 9–12: Our main goal for these chapters was to provide better explanations and more diagrams. Chapters 9 and 10 focus more on immutable vs mutable objects, and we added new sections on BigInteger and StringBuilder. The other content is largely the same, but it should be easier to understand now.

Chapters 13–16: We balanced the amount of content in Chapters 13–14 by moving ArrayLists earlier, and we implement the “War” card game as another example. Chapters 15–16 are brand new in this edition, and they cover more advanced topics including interfaces, polymorphism, and multi-dimensional arrays.

Appendixes: We added Appendix B to explain documentation comments and Javadoc in more detail and Appendix E to present special topics. The other three appendixes that were present in the first edition have been revised for clarity and layout.

About the Appendixes

The chapters of this book are meant to be read in order, because each one builds on the previous one. We also include several appendixes with material that can be read at any time:

Appendix A: Tools

This appendix explains how to download and install Java so you can compile programs on your computer. It also provides a brief introduction to DrJava – an “integrated development environment” (IDE) that is designed primarily for students – and other development tools, including Checkstyle for code quality and JUnit for testing.

Appendix B: Javadoc

It’s important to document your classes and methods so that other programmers (including yourself in the future) will know how to use them. This appendix explains how to read documentation, how to write documentation, and how to use the Javadoc tool.

Appendix C: Graphics

Java provides libraries for working with graphics and animation, and these topics can be engaging for students. The libraries require object-oriented features that students will not completely understand until after Chapter 10, but they can be used much earlier.

Appendix D: Debugging

We provide debugging suggestions throughout the book, but we also have an appendix with many more suggestions on how to debug your programs. We recommend that readers review this appendix frequently as they work through the book.

Appendix E: Extras

With each new edition, we add new material, remove old material, and revise everything else. Some of the old material may still be useful, so rather than delete it, we moved it to this appendix.

Using the Code Examples

Most of the code examples in this book are available from a Git repository at <https://github.com/ChrisMayfield/ThinkJavaCode2>. Git is a “version control system” that allows you to keep track of the files that make up a project. A collection of files under Git’s control is called a “repository”.

GitHub is a hosting service that provides storage for Git repositories and a convenient web interface. It provides several ways to work with the code:

- You can create a copy of the repository on GitHub by pressing the Fork button. If you don’t already have a GitHub account, you’ll need to create one. After forking, you’ll have your own repository on GitHub that you can use to keep track of code you write. Then you can “clone” the repository, which downloads a copy of the files to your computer.
- Alternatively, you could clone the original repository without forking. If you choose this option, you don’t need a GitHub account, but you won’t be able to save your changes on GitHub.
- If you don’t want to use Git at all, you can download the code in a ZIP archive using the Download ZIP button on the GitHub page, or this link: <https://thinkjava.org/code2zip>.

After you clone the repository or unzip the ZIP file, you should have a directory named `ThinkJavaCode2` with a subdirectory for each chapter in the book.

All examples in this book were developed and tested using Java SE Development Kit 8. If you are using a more recent version, the examples in this book should still work. If you are using an older version, some of them may not.

Acknowledgments

Many people have sent corrections and suggestions over the years, and we appreciate their valuable feedback! This list begins with Version 4.0 of the open-source edition, so it omits those who contributed to earlier versions.

- Ellen Hildreth used this book to teach Data Structures at Wellesley College and submitted a whole stack of corrections, along with some great suggestions.
- Tania Passfield pointed out that some glossaries had leftover terms that no longer appeared in the text.
- Elizabeth Wiethoff noticed that the series expansion of $\exp(-x^2)$ was wrong. She has also worked on a Ruby version of the book.
- Matt Crawford sent in a whole patch file full of corrections.
- Chi-Yu Li pointed out a typo and an error in one of the code examples.
- Doan Thanh Nam corrected an example.
- Muhammad Saied translated the book into Arabic, and found several errors in the process.
- Marius Margowski found an inconsistency in a code example.
- Leslie Klein discovered another error in the series expansion of $\exp(-x^2)$, identified typos in the card array figures, and gave helpful suggestions to clarify several exercises.
- Micah Lindstrom reported half a dozen typos and sent corrections.
- James Riely ported the textbook source from LaTeX to Sphinx.
<http://fpl.cs.depaul.edu/jriely/thinkapjava/>
- Peter Knaggs ported the book to C#.
<https://www.rigwit.co.uk/think/sharp/>
- Heidi Gentry-Kolen recorded several video lectures that follow the book.
<https://www.youtube.com/user/digipipeline>
- Waldo Ribeiro submitted a pull request that corrected a dozen typos.
- Michael Stewart made several suggestions for improving the first half of the book.
- Steven Richardson adapted the book for an online course and contributed many ideas for improving the text.

We are especially grateful to the technical reviewers of the O'Reilly Media first edition: Blythe Samuels, David Wisneski, and Stephen Rose. They found errors, made many great suggestions, and helped make the book much better.

Many students have given exceptional feedback, including Ian Staton, Tanner Wernecke, Jacob Green, Rasha Abuhantash, Nick Duncan, Kylie Davidson, Shirley Jiang, Elena Trafton, Jennifer Gregorio, and Azeem Mufti.

Other contributors who found one or more typos: Stijn Debrouwere, Guy Driesen, Andai Velican, Chris Kuszmaul, Daniel Kurikesu, Josh Donath, Rens Findhammer, Elisa Abedrapo, Yousef BaAfif, Bruce Hill, Matt Underwood, Isaac Sultan, Dan Rice, Robert Beard, Daniel Pierce, Michael Giftthaler, Chris Fox, Min Zeng, Markus Geuss, Mauricio Gonzalez, Enrico Sartirana, Kasem Satitwiwat, and Jason Miller.

If you have additional comments or ideas about the text, please send them to: feedback@greenteapress.com.

Allen Downey and Chris Mayfield

Chapter 1

Computer Programming

The goal of this book is to teach you to think like a computer scientist. This way of thinking combines some of the best features of mathematics, engineering, and natural science. Like mathematicians, computer scientists use formal languages to denote ideas, specifically computations. Like engineers, they design things, assembling components into systems and evaluating trade-offs among alternatives. And like scientists, they observe the behavior of complex systems, form hypotheses, and test predictions.

An important skill for a computer scientist is **problem solving**. It involves the ability to formulate problems, think creatively about solutions, and express solutions clearly and accurately. As it turns out, the process of learning to program computers is an excellent opportunity to develop problem-solving skills. On one level you will be learning to write Java programs, a useful skill by itself. But on another level you will use programming as a means to an end. As we go along, that end will become clearer.

1.1 What Is a Computer?

When people hear the word computer, they often think of a desktop or laptop. Not surprisingly, searching for “computer” on <https://images.google.com/> displays rows and rows of these types of machines. However, in a more general sense, a computer can be any type of device that stores and processes data.

Dictionary.com defines a computer as “a programmable electronic device designed to accept data, perform prescribed mathematical and logical operations at high speed, and display the results of these operations. Mainframes, desktop and laptop computers, tablets, and smartphones are some of the different types of computers.”

Each type of computer has its own unique design, but internally they all share the same type of **hardware**. The two most important hardware components are **processors** (or CPUs) that perform simple calculations and **memory** (or RAM) that temporarily stores information. Figure 1.1 shows what these components look like.



Figure 1.1: Example processor and memory hardware.

Users generally see and interact with touchscreens, keyboards, and monitors, but it’s the processors and memory that perform the actual computation. Nowadays it’s fairly standard, even for a smartphone, to have at least eight processors and four gigabytes (four billion cells) of memory.

1.2 What Is Programming?

A **program** is a sequence of instructions that specifies how to perform a computation on computer hardware. The computation might be something mathematical, like solving a system of equations or finding the roots of a polynomial. It could also be a symbolic computation, like searching and replacing text in a document or (strangely enough) compiling a program.

The details look different in different languages, but a few basic instructions appear in just about every language:

input: Get data from the keyboard, a file, a sensor, or some other device.

output: Display data on the screen, or send data to a file or other device.

math: Perform basic mathematical operations like addition and division.

decision: Check for certain conditions and execute the appropriate code.

repetition: Perform some action repeatedly, usually with some variation.

Believe it or not, that's pretty much all there is to it. Every program you've ever used, no matter how complicated, is made up of small instructions that look much like these. So you can think of **programming** as the process of breaking down a large, complex task into smaller and smaller subtasks. The process continues until the subtasks are simple enough to be performed with the electronic circuits provided by the hardware.

1.3 The Hello World Program

Traditionally, the first program you write when learning a new programming language is called the hello world program. All it does is output the words "Hello, World!" to the screen. In Java, it looks like this:

```
public class Hello {  
  
    public static void main(String[] args) {  
        // generate some simple output  
        System.out.println("Hello, World!");  
    }  
}
```

When this program runs it displays:

```
Hello, World!
```

Notice that the output does not include the quotation marks.

Java programs are made up of *class* and *method* definitions, and methods are made up of *statements*. A **statement** is a line of code that performs a

basic action. In the hello world program, this line is a **print statement** that displays a message to the user:

```
System.out.println("Hello, World!");
```

`System.out.println` displays results on the screen; the name `println` stands for “print line”. Confusingly, *print* can mean both “display on the screen” and “send to the printer”. In this book, we’ll try to say “display” when we mean output to the screen. Like most statements, the print statement ends with a semicolon (;).

Java is “case-sensitive”, which means that uppercase and lowercase are not the same. In the hello world program, `System` has to begin with an uppercase letter; `system` and `SYSTEM` won’t work.

A **method** is a named sequence of statements. This program defines one method named `main`:

```
public static void main(String[] args)
```

The name and format of `main` is special: when the program runs, it starts at the first statement in `main` and ends when it finishes the last statement. Later, we will see programs that define more than one method.

This program defines a class named `Hello`. For now, a **class** is a collection of methods; we’ll have more to say about this later. You can give a class any name you like, but it is conventional to start with a capital letter. The name of the class has to match the name of the file it is in, so this class has to be in a file named `Hello.java`.

Java uses curly braces ({ and }) to group things together. In `Hello.java`, the outermost braces contain the class definition, and the inner braces contain the method definition.

The line that begins with two slashes (//) is a **comment**, which is a bit of English text that explains the code. When Java sees //, it ignores everything from there until the end of the line. Comments have no effect on the execution of the program, but they make it easier for other programmers (and your future self) to understand what you meant to do.

1.4 Compiling Java Programs

The programming language you will learn in this book is Java, which is a **high-level language**. Other high-level languages you may have heard of include Python, C and C++, PHP, Ruby, and JavaScript.

Before they can run, programs in high-level languages have to be translated into a **low-level language**, also called “machine language”. This translation takes some time, which is a small disadvantage of high-level languages. But high-level languages have two major advantages:

- It is *much* easier to program in a high-level language. Programs take less time to write, they are shorter and easier to read, and they are more likely to be correct.
- High-level languages are **portable**, meaning they can run on different kinds of computers with few or no modifications. Low-level programs can only run on one kind of computer.

Two kinds of programs translate high-level languages into low-level languages: interpreters and compilers. An **interpreter** reads a high-level program and executes it, meaning that it does what the program says. It processes the program a little at a time, alternately reading lines and performing computations. Figure 1.2 shows the structure of an interpreter.

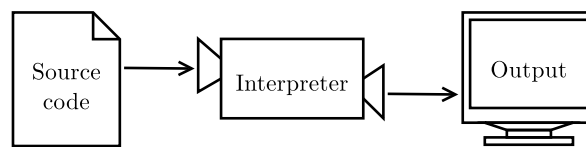

Figure 1.2: How interpreted languages are executed.

In contrast, a **compiler** reads the entire program and translates it completely before the program starts running. In this context, the high-level program is called the **source code**. The translated program is called the **object code** or the **executable**. Once a program is compiled, you can execute it repeatedly without further translation. As a result, compiled programs often run faster than interpreted programs.

Note that object code, as a low-level language, is not portable. You cannot run an executable compiled for a Windows laptop on an Android phone, for

example. In order to run a program on different types of machines, it must be compiled multiple times. It can be difficult to write source code that compiles and runs correctly on different types of machines.

To address this issue, Java is *both* compiled and interpreted. Instead of translating source code directly into an executable, the Java compiler generates code for a **virtual machine**. This “imaginary” machine has the functionality common to desktops, laptops, tablets, phones, etc. Its language, called Java **byte code**, looks like object code and is easy and fast to interpret.

As a result, it’s possible to compile a Java program on one machine, transfer the byte code to another machine, and run the byte code on the other machine. Figure 1.3 shows the steps of the development process. The Java compiler is a program named `javac`. It translates `.java` files into `.class` files that store the resulting byte code. The Java interpreter is another program, named `java`, which is short for “Java Virtual Machine” (JVM).

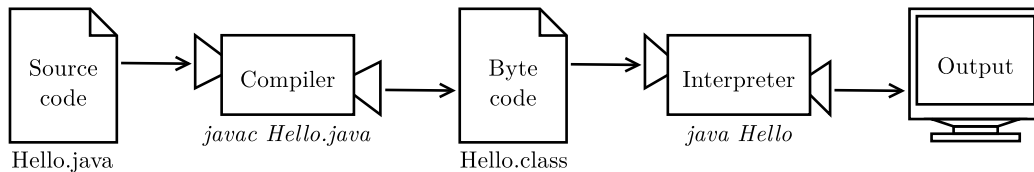

Figure 1.3: The process of compiling and running a Java program.

The programmer writes source code in the file `Hello.java` and uses `javac` to compile it. If there are no errors, the compiler saves the byte code in the file `Hello.class`. To run the program, the programmer uses `java` to interpret the byte code. The result of the program is then displayed on the screen.

Although it might seem complicated, these steps are automated for you in most development environments. Usually you only have to press a button or type a single command to compile and interpret your program. On the other hand, it is important to know what steps are happening in the background, so if something goes wrong you can figure out what it is.

1.5 Displaying Two Messages

You can put as many statements as you like in the `main` method. For example, to display more than one line of output:

```
public class Hello2 {  
  
    public static void main(String[] args) {  
        // generate some simple output  
        System.out.println("Hello, World!"); // first line  
        System.out.println("How are you?"); // another line  
    }  
}
```

As this example also shows, you can put comments at the end of a line as well as on lines all by themselves.

Phrases that appear in quotation marks are called **strings**, because they contain a sequence of characters strung together in memory. Characters can be letters, numbers, punctuation marks, symbols, spaces, tabs, etc.

`System.out.println` appends a special character, called a **newline**, that moves to the beginning of the next line. If you don't want a newline at the end, you can use `print` instead of `println`:

```
public class Goodbye {  
  
    public static void main(String[] args) {  
        System.out.print("Goodbye, ");  
        System.out.println("cruel world");  
    }  
}
```

In this example, the first statement does not add a newline, so the output appears on a single line:

```
Goodbye, cruel world
```

Notice that there is a space at the end of the first string, which appears in the output just before the word `cruel`.

1.6 Formatting Source Code

In Java source code, some spaces are required. For example, you need at least one space between words, so this program is not legal:

```
publicclassGoodbye{  
  
    publicstaticvoidmain(String[] args) {  
        System.out.print("Goodbye, ");  
        System.out.println("cruel world");  
    }  
}
```

But most other spaces are optional. For example, this program *is* legal:

```
public class Goodbye {  
public static void main(String[] args) {  
System.out.print("Goodbye, ");  
System.out.println("cruel world");  
}  
}
```

The newlines are optional, too. So we could just write:

```
public class Goodbye { public static void main(String[] args)  
{ System.out.print("Goodbye, "); System.out.println  
("cruel world");}}
```

It still works, but the program is getting harder and harder to read. Newlines and spaces are important for organizing your program visually, making it easier to understand the program and find errors when they occur.

Many editors will automatically format source code with consistent indenting and line breaks. For example, in DrJava (see Appendix A.1) you can indent your code by selecting all text (Ctrl+A) and pressing the Tab key.

Organizations that do a lot of software development usually have strict guidelines on how to format source code. For example, Google publishes its Java coding standards for use in open-source projects: <https://google.github.io/styleguide/javaguide.html>.

You probably won't understand these guidelines now, because they refer to language features we haven't yet seen. But you might want to refer back to them periodically as you read this book.

1.7 Escape Sequences

It's possible to display multiple lines of output with only one line of code. You just have to tell Java where to put the line breaks.

```
public class Hello3 {  
  
    public static void main(String[] args) {  
        System.out.print("Hello!\nHow are you doing?\n");  
    }  
}
```

The output is two lines, each ending with a newline character:

```
Hello!  
How are you doing?
```

Each `\n` is an **escape sequence**, or two characters of source code that represent a single character. (The backslash allows you to “escape” the string to write special characters.) Notice there is no space between `\n` and `How`. If you add a space there, there will be a space at the beginning of the second line.

<code>\n</code>	newline
<code>\t</code>	tab
<code>\"</code>	double quote
<code>\\</code>	backslash

Table 1.1: Common escape sequences

Java has a total of eight escape sequences, and the four most commonly used ones are listed in Table 1.1. For example, to write quotation marks inside of strings, you need to escape them with a backslash.

```
System.out.println("She said \"Hello!\" to me.");
```

The result is:

```
She said "Hello!" to me.
```

1.8 What Is Computer Science?

This book intentionally omits some details about the Java language (such as the other escape sequences), because our main goal is learning how to think like a computer scientist. Being able to understand computation is much more valuable than just learning how to write code.

If you're interested in learning more about Java itself, Oracle maintains an official set of tutorials on their website: <https://thinkjava.org/tutorial>. The “Language Basics” tutorial (found under “Learning the Java Language”) is a good place to start.

One of the most interesting aspects of writing programs is deciding how to solve a particular problem, especially when there are multiple solutions. For example, there are numerous ways to sort a list of numbers, and each way has its advantages. In order to determine which way is best for a given situation, we need techniques for describing and analyzing solutions formally.

An **algorithm** is a sequence of steps that specifies how to solve a problem. Some algorithms are faster than others, and some use less space in computer memory. **Computer science** is the science of algorithms, including their discovery and analysis. As you learn to develop algorithms for problems you haven't solved before, you will learn to think like a computer scientist.

Designing algorithms and writing code is difficult and error-prone. For historical reasons, programming errors are called **bugs**, and the process of tracking them down and correcting them is called **debugging**. As you learn to debug your programs, you will develop new problem-solving skills. You will need to think creatively when unexpected errors happen.

Although it can be frustrating, debugging is an intellectually rich, challenging, and interesting part of computer science. In some ways, debugging is like detective work. You are confronted with clues, and you have to infer the processes and events that led to the results you see. Thinking about how to correct programs and improve their performance sometimes even leads to the discovery of new algorithms.

1.9 Debugging Programs

It is a good idea to read this book in front of a computer so you can try out the examples as you go. You can run many of the examples directly in DrJava's Interactions Pane (see Appendix A.2). But if you put the code in a source file, it will be easier to try out variations.

Whenever you are experimenting with a new feature, you should also try to make mistakes. For example, in the hello world program, what happens if you leave out one of the quotation marks? What if you leave out both? What if you spell `println` wrong? These kinds of experiments help you remember what you read. They also help with debugging, because you learn what the error messages mean. It is better to make mistakes now and on purpose than later on and accidentally.

Debugging is like an experimental science: once you have an idea about what is going wrong, you modify your program and try again. If your hypothesis was correct, then you can predict the result of the modification, and you take a step closer to a working program. If your hypothesis was wrong, you have to come up with a new one.

Programming and debugging should go hand in hand. Don't just write a bunch of code and then perform trial and error debugging until it all works. Instead, start with a program that does *something* and make small modifications, debugging them as you go, until the program does what you want. That way you will always have a working program, and it will be easier to isolate errors.

A great example of this principle is the Linux operating system, which contains millions of lines of code. It started out as a simple program Linus Torvalds used to explore the Intel 80386 chip. According to Larry Greenfield in *The Linux Users' Guide*, "One of Linus's earlier projects was a program that would switch between printing AAAA and BBBB. This later evolved to Linux."

Finally, programming sometimes brings out strong emotions. If you are struggling with a difficult bug, you might feel angry, despondent, or embarrassed. Remember that you are not alone, and virtually every programmer has had similar experiences. Don't hesitate to reach out to a friend and ask questions!

1.10 Vocabulary

Throughout the book, we try to define each term the first time we use it. At the end of each chapter, we include the new terms and their definitions in order of appearance. If you spend some time learning this vocabulary, you will have an easier time reading the following chapters.

problem solving: The process of formulating a problem, finding a solution, and expressing the solution.

hardware: The electronic and mechanical components of a computer, such as CPUs, RAM, and hard disks.

processor: A computer chip that performs simple instructions like basic arithmetic and logic.

memory: Circuits that store data as long as the computer is turn on. Not to be confused with permanent storage devices like hard disks and flash.

program: A sequence of instructions that specifies how to perform tasks on a computer. Also known as software.

programming: The application of problem solving to creating executable computer programs.

statement: Part of a program that specifies one step of an algorithm.

print statement: A statement that causes output to be displayed on the screen.

method: A named sequence of statements.

class: For now, a collection of related methods. (We will see later that there is a lot more to it.)

comment: A part of a program that contains information about the program but has no effect when the program runs.

high-level language: A programming language that is designed to be easy for humans to read and write.

low-level language: A programming language that is designed to be easy for a computer to run. Also called “machine language”.

portable: The ability of a program to run on more than one kind of computer.

interpret: To run a program in a high-level language by translating it one line at a time and immediately executing the corresponding instructions.

compile: To translate a program in a high-level language into a low-level language, all at once, in preparation for later execution.

source code: A program in a high-level language, before being compiled.

object code: The output of the compiler, after translating the program.

executable: Another name for object code that is ready to run on specific hardware.

virtual machine: An emulation of a real machine. The Java Virtual Machine enables a computer to run Java programs.

byte code: A special kind of object code used for Java programs. Byte code is similar to object code, but it is portable like a high-level language.

string: A sequence of characters; the primary data type for text.

newline: A special character signifying the end of a line of text. Also known as line ending, end of line (EOL), or line break.

escape sequence: A sequence of code that represents a special character when used inside a string.

algorithm: A procedure or formula for solving a problem, with or without a computer.

computer science: The scientific and practical approach to computation and its applications.

bug: An error in a program.

debugging: The process of finding and removing errors.

1.11 Exercises

At the end of each chapter, we include exercises you can do with the things you've learned. We encourage you to at least attempt every problem. You can't learn to program only by reading about it; you have to practice.

Before you can compile and run Java programs, you might have to download and install a few tools. There are many good options, but we recommend DrJava, which is an "integrated development environment" (IDE) well suited for beginners. Instructions for getting started are in Appendix A.

The code for this chapter is in the `ch01` directory of `ThinkJavaCode2`. See page xix for instructions on how to download the repository. Before you start the exercises, we recommend that you compile and run the examples.

Exercise 1.1 Computer scientists have the annoying habit of using common English words to mean something other than their common English meaning. For example, in English, statements and comments are the same thing, but in programs they are different.

1. In computer jargon, what's the difference between a statement and a comment?
2. What does it mean to say that a program is portable?
3. In common English, what does the word compile mean?
4. What is an executable? Why is that word used as a noun?

The glossary at the end of each chapter is intended to highlight words and phrases that have special meanings in computer science. When you see familiar words, don't assume that you know what they mean!

Exercise 1.2 Before you do anything else, find out how to compile and run a Java program. Some environments provide sample programs similar to the example in Section 1.3.

1. Type in the hello world program, then compile and run it.
2. Add a print statement that displays a second message after the "Hello, World!". Say something witty like, "How are you?" Compile and run the program again.

3. Add a comment to the program (anywhere), recompile, and run it again. The new comment should not affect the result.

This exercise may seem trivial, but it is the starting place for many of the programs we will work with. To debug with confidence, you will need to have confidence in your programming environment.

In some environments, it is easy to lose track of which program is executing. You might find yourself trying to debug one program while you are accidentally running another. Adding (and changing) print statements is a simple way to be sure that the program you are looking at is the program you are running.

Exercise 1.3 It is a good idea to commit as many errors as you can think of, so that you see what error messages the compiler produces. Sometimes the compiler tells you exactly what is wrong, and all you have to do is fix it. But sometimes the error messages are misleading. Over time you will develop a sense for when you can trust the compiler and when you have to figure things out yourself.

Starting with the hello world program, try out each of the following errors. After you make each change, compile the program, read the error message (if there is one), and then fix the error.

1. Remove one of the open curly braces.
2. Remove one of the close curly braces.
3. Instead of `main`, write `mian`.
4. Remove the word `static`.
5. Remove the word `public`.
6. Remove the word `System`.
7. Replace `println` with `Println`.
8. Replace `println` with `print`.
9. Delete one of the parentheses.
10. Add an extra parenthesis.

Chapter 2

Variables and Operators

This chapter describes how to write statements using *variables*, which store values like numbers and words, and *operators*, which are symbols that perform a computation. We also explain three kinds of programming errors and offer additional debugging advice.

To run the examples in this chapter, you will need to create a new Java class with a `main` method (see Section 1.3). Throughout the book, we often omit class and method definitions to keep the examples concise.

2.1 Declaring Variables

One of the most powerful features of a programming language is the ability to define and manipulate **variables**. A variable is a named location in memory that stores a **value**. Values may be numbers, text, images, sounds, and other types of data. To store a value, you first have to declare a variable.

```
String message;
```

This statement is called a **declaration**, because it declares that the variable `message` has the type `String`. Each variable has a **type** that determines what kind of values it can store. For example, the `int` type can store integers like 1 and -5, and the `char` type can store characters like `'A'` and `'z'`.

Some types begin with a capital letter and some with lowercase. We will learn the significance of this distinction later, but for now you should take care to get it right. There is no such type as `Int` or `string`.

To declare an integer variable named `x`, you simply type:

```
int x;
```

Note that `x` is an arbitrary name for the variable. In general, you should use names that indicate what the variables mean.

```
String firstName;  
String lastName;  
int hour, minute;
```

This example declares two variables with type `String` and two with type `int`. The last line shows how to declare multiple variables with the same type: `hour` and `minute` are both integers. Note that each declaration statement ends with a semicolon (`;`).

Variable names usually begin with a lowercase letter, in contrast to class names (like `Hello`) that start with a capital letter. When a variable name contains more than one word (like `firstName`), it is conventional to capitalize the first letter of each subsequent word. Variable names are case-sensitive, so `firstName` is not the same as `firstname` or `FirstName`.

You can use any name you want for a variable. But there are about 50 reserved words, called **keywords**, that you are not allowed to use as variable names. These words include `public`, `class`, `static`, `void`, and `int`, which are used by the compiler to analyze the structure of the program.

You can see the full list of keywords at <https://thinkjava.org/keywords>, but you don't have to memorize them. Most programming editors provide "syntax highlighting", which makes different parts of the program appear in different colors. And the compiler will complain even if one does sneak past you and your editor.

2.2 Assigning Variables

Now that we have declared some variables, we can use them to store values. We do that with an **assignment** statement.

```
message = "Hello!"; // give message the value "Hello!"
hour = 11;          // assign the value 11 to hour
minute = 59;       // set minute to 59
```

This example shows three assignments, and the comments illustrate different ways people sometimes talk about assignment statements. The vocabulary can be confusing here, but the idea is straightforward:

- When you declare a variable, you create a named storage location.
- When you make an assignment to a variable, you update its value.

As a general rule, a variable has to have the same type as the value you assign to it. For example, you cannot store a string in `minute` or an integer in `message`. We will see some examples that seem to break this rule, but we'll get to that later.

A common source of confusion is that some strings *look* like integers, but they are not. For example, `message` can contain the string `"123"`, which is made up of the characters `'1'`, `'2'`, and `'3'`. But that is not the same thing as the integer 123.

```
message = "123"; // legal
message = 123;  // not legal
```

Variables must be **initialized** (assigned for the first time) before they can be used. You can declare a variable and then assign a value later, as in the previous example. You can also declare and initialize on the same line:

```
String message = "Hello!";
int hour = 11;
int minute = 59;
```

2.3 Memory Diagrams

Because Java uses the `=` symbol for assignment, it is tempting to interpret the statement `a = b` as a statement of equality. It is not!

Equality is commutative, and assignment is not. For example, in mathematics if $a = 7$ then $7 = a$. In Java `a = 7;` is a legal assignment statement, but

`7 = a;` is not. The left side of an assignment statement has to be a variable name (storage location).

Also, in mathematics, a statement of equality is true for all time. If $a = b$ now, a is always equal to b . In Java, an assignment statement can make two variables equal, but they don't have to stay that way.

```
int a = 5;
int b = a;    // a and b are now equal
a = 3;       // a and b are no longer equal
```

The third line changes the value of `a`, but it does not change the value of `b`, so they are no longer equal.

Taken together, the variables in a program and their current values make up the program's **state**. Figure 2.1 shows the state of the program after these assignment statements run.

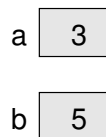

Figure 2.1: Memory diagram of the variables `a` and `b`.

Diagrams like this one that show the state of the program are called **memory diagrams**. Each variable is represented with a box showing the name of the variable on the outside and its current value inside.

As the program runs, the state of memory changes, so memory diagrams only show a particular point in time. For example, if we added the line `int c = 0;` to the previous example, the memory diagram would look like Figure 2.2.

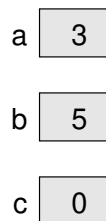

Figure 2.2: Memory diagram of the variables `a`, `b`, and `c`.

2.4 Printing Variables

You can display the current value of a variable using `print` or `println`. The following statements declare a variable named `firstLine`, assign it the value `"Hello, again!"`, and display that value.

```
String firstLine = "Hello, again!";  
System.out.println(firstLine);
```

When we talk about displaying a variable, we generally mean the *value* of the variable. To display the *name* of a variable, you have to put it in quotes.

```
System.out.print("The value of firstLine is ");  
System.out.println(firstLine);
```

For this example, the output is:

```
The value of firstLine is Hello, again!
```

Conveniently, the code for displaying a variable is the same regardless of its type. For example:

```
int hour = 11;  
int minute = 59;  
System.out.print("The current time is ");  
System.out.print(hour);  
System.out.print(":");  
System.out.print(minute);  
System.out.println(":");
```

The output of this program is:

```
The current time is 11:59.
```

To output multiple values on the same line, it's common to use several `print` statements followed by `println` at the end. But don't forget the `println`! On many computers, the output from `print` is stored without being displayed until `println` is run; then the entire line is displayed at once. If you omit the `println`, the program might display the stored output at unexpected times or even terminate without displaying anything.

2.5 Arithmetic Operators

Operators are symbols that represent simple computations. For example, the addition operator is `+`, subtraction is `-`, multiplication is `*`, and division is `/`.

The following program converts a time of day to minutes:

```
int hour = 11;
int minute = 59;
System.out.print("Number of minutes since midnight: ");
System.out.println(hour * 60 + minute);
```

The output is:

```
Number of minutes since midnight: 719
```

In this program, `hour * 60 + minute` is an **expression**, which represents a single value to be computed (719). When the program runs, each variable is replaced by its current value, and then the operators are applied. The values that operators work with are called **operands**.

Expressions are generally a combination of numbers, variables, and operators. When compiled and executed, they become a single value. For example, the expression `1 + 1` has the value 2. In the expression `hour - 1`, Java replaces the variable with its value, yielding `11 - 1`, which has the value 10.

In the expression `hour * 60 + minute`, both variables get replaced, yielding `11 * 60 + 59`. The multiplication happens first, yielding `660 + 59`. Then the addition yields 719.

Addition, subtraction, and multiplication all do what you expect, but you might be surprised by division. For example, the following fragment tries to compute the fraction of an hour that has elapsed:

```
System.out.print("Fraction of the hour that has passed: ");
System.out.println(minute / 60);
```

The output is:

```
Fraction of the hour that has passed: 0
```

This result often confuses people. The value of `minute` is 59, and 59 divided by 60 should be 0.98333, not 0. The problem is that Java performs “integer division” when the operands are integers. By design, integer division always rounds toward zero, even in cases like this one where the next integer is close.

As an alternative, we can calculate a percentage rather than a fraction:

```
System.out.print("Percent of the hour that has passed: ");
System.out.println(minute * 100 / 60);
```

The new output is:

```
Percent of the hour that has passed: 98
```

Again the result is rounded down, but at least now it’s approximately correct.

2.6 Floating-Point Numbers

A more general solution is to use **floating-point** numbers, which represent values with decimal places. In Java, the default floating-point type is called **double**, which is short for double-precision. You can create **double** variables and assign values to them the same way we did for the other types:

```
double pi;
pi = 3.14159;
```

Java performs “floating-point division” when one or more operands are **double** values. So we can solve the problem we saw in the previous section:

```
double minute = 59.0;
System.out.print("Fraction of the hour that has passed: ");
System.out.println(minute / 60.0);
```

The output is:

```
Fraction of the hour that has passed: 0.9833333333333333
```

Although floating-point numbers are useful, they can be a source of confusion. For example, Java distinguishes the integer value 1 from the floating-point value 1.0, even though they seem to be the same number. They belong to

different data types, and strictly speaking, you are not allowed to make assignments between types.

The following is illegal because the variable on the left is an `int` and the value on the right is a `double`:

```
int x = 1.1; // compiler error
```

It is easy to forget this rule, because in many cases Java *automatically* converts from one type to another:

```
double y = 1; // legal, but bad style
```

The preceding example should be illegal, but Java allows it by converting the `int` value 1 to the `double` value 1.0 automatically. This leniency is convenient, but it often causes problems for beginners. For example:

```
double y = 1 / 3; // common mistake
```

You might expect the variable `y` to get the value 0.333333, which is a legal floating-point value. But instead it gets the value 0.0. The expression on the right divides two integers, so Java does integer division, which yields the `int` value 0. Converted to `double`, the value assigned to `y` is 0.0.

One way to solve this problem (once you figure out the bug) is to make the right-hand side a floating-point expression. The following sets `y` to 0.333333, as expected:

```
double y = 1.0 / 3.0; // correct
```

As a matter of style, you should always assign floating-point values to floating-point variables. The compiler won't make you do it, but you never know when a simple mistake will come back and haunt you.

2.7 Rounding Errors

Most floating-point numbers are only *approximately* correct. Some numbers, like reasonably-sized integers, can be represented exactly. But repeating fractions, like 1/3, and irrational numbers, like π , cannot. To represent these numbers, computers have to round off to the nearest floating-point number.

The difference between the number we want and the floating-point number we get is called **rounding error**. For example, the following two statements should be equivalent:

```
System.out.println(0.1 * 10);
System.out.println(0.1 + 0.1 + 0.1 + 0.1 + 0.1
                  + 0.1 + 0.1 + 0.1 + 0.1 + 0.1);
```

But on many machines, the output is:

```
1.0
0.9999999999999999
```

The problem is that 0.1 is a repeating fraction when converted into binary. So its floating-point representation stored in memory is only approximate. When we add up the approximations, the rounding errors accumulate.

For many applications, like computer graphics, encryption, statistical analysis, and multimedia rendering, floating-point arithmetic has benefits that outweigh the costs. But if you need *absolute* precision, use integers instead. For example, consider a bank account with a balance of \$123.45:

```
double balance = 123.45; // potential rounding error
```

In this example, balances will become inaccurate over time as the variable is used in arithmetic operations like deposits and withdrawals. The result would be angry customers and potential lawsuits. You can avoid the problem by representing the balance as an integer:

```
int balance = 12345; // total number of cents
```

This solution works as long as the number of cents doesn't exceed the largest `int`, which is about 2 billion.

2.8 Operators for Strings

In general, you cannot perform mathematical operations on strings, even if the strings look like numbers. The following expressions are illegal:

```
"Hello" - 1      "World" / 123      "Hello" * "World"
```

The `+` operator works with strings, but it might not do what you expect. For strings, the `+` operator performs **concatenation**, which means joining end-to-end. So `"Hello, " + "World!"` yields the string `"Hello, World!"`.

Likewise if you have a variable called `name` that has type `String`, the expression `"Hello, " + name` appends the value of `name` to the hello string, which creates a personalized greeting.

Since addition is defined for both numbers and strings, Java performs automatic conversions you may not expect:

```
System.out.println(1 + 2 + "Hello");  
// the output is 3Hello  
  
System.out.println("Hello" + 1 + 2);  
// the output is Hello12
```

Java executes these operations from left to right. In the first line, `1 + 2` is 3, and `3 + "Hello"` is `"3Hello"`. But in the second line, `"Hello" + 1` is `"Hello1"`, and `"Hello1" + 2` is `"Hello12"`.

When more than one operator appears in an expression, they are evaluated according to the **order of operations**. Generally speaking, Java evaluates operators from left to right (as we saw in the previous section). But for numeric operators, Java follows mathematical conventions:

- Multiplication and division take “precedence” over addition and subtraction, which means they happen first. So `1 + 2 * 3` yields 7, not 9, and `2 + 4 / 2` yields 4, not 3.
- If the operators have the same precedence, they are evaluated from left to right. So in the expression `minute * 100 / 60`, the multiplication happens first; if the value of `minute` is 59, we get `5900 / 60`, which yields 98. If these same operations had gone from right to left, the result would have been `59 * 1`, which is incorrect.
- Any time you want to override the order of operations (or you are not sure what it is) you can use parentheses. Expressions in parentheses are evaluated first, so `(1 + 2) * 3` is 9. You can also use parentheses to make an expression easier to read, as in `(minute * 100) / 60`, even though it doesn’t change the result.

See the official Java tutorials for a complete table of operator precedence: <https://thinkjava.org/operators>. If the order of operations is not obvious when looking at an expression, you can always add parentheses to make it more clear. But over time, you should internalize these kinds of details about the Java language.

2.9 Compiler Error Messages

Three kinds of errors can occur in a program: compile-time errors, run-time errors, and logic errors. It is useful to distinguish among them in order to track them down more quickly.

Compile-time errors occur when you violate the rules of the Java language. For example, parentheses and braces have to come in matching pairs. So `(1 + 2)` is legal, but `8)` is not. In the latter case, the program cannot be compiled, and the compiler displays a “syntax error”.

Error messages from the compiler usually indicate where in the program the error occurred. Sometimes they can tell you exactly what the error is. As an example, let’s get back to the hello world program from Section 1.3.

```
public class Hello {  
  
    public static void main(String[] args) {  
        // generate some simple output  
        System.out.println("Hello, World!");  
    }  
}
```

If you forget the semicolon at the end of the print statement, you might get an error message like this:

```
File: Hello.java [line: 5]  
Error: ';' expected
```

That’s pretty good: the location of the error is correct, and the error message tells you what’s wrong. But error messages are not always easy to understand. Sometimes the compiler reports the place in the program where the error was

detected, not where it actually occurred. And sometimes the description of the problem is more confusing than helpful.

For example, if you forget the closing brace at the end of `main` (line 6), you might get a message like this:

```
File: Hello.java [line: 7]
Error: reached end of file while parsing
```

There are two problems here. First, the error message is written from the compiler's point of view, not yours. **Parsing** is the process of reading a program before translating; if the compiler gets to the end of the file while still parsing, that means something was omitted. But the compiler doesn't know what. It also doesn't know where. The compiler discovers the error at the end of the program (line 7), but the missing brace should be on the previous line.

Error messages contain useful information, so you should make an effort to read and understand them. But don't take them too literally. During the first few weeks of your programming career, you will probably spend a lot of time tracking down syntax and other compile-time errors. As you gain experience, you will make fewer mistakes and find them more quickly.

2.10 Other Types of Errors

The second type of error is a **run-time error**, so-called because it does not appear until after the program has started running. In Java, these errors occur while the interpreter is executing byte code and something goes wrong. These errors are also called "exceptions" because they usually indicate that something unexpected has happened.

Run-time errors are rare in the simple programs you will see in the first few chapters, so it might be a while before you encounter one. When a run-time error occurs, the program "crashes" (terminates) and displays an error message that explains what happened and where. For example, if you accidentally divide by zero you will get a message like:

```
Exception in thread "main" java.lang.ArithmeticException: / by zero
at Hello.main(Hello.java:5)
```

Error messages are very useful for debugging. The first line includes the name of the exception, `ArithmeticException`, and a message that indicates more specifically what happened, division by zero. The next line shows the method where the error occurred; `Hello.main` indicates the method `main` in the class `Hello`. It also reports the file where the method is defined, `Hello.java`, and the line number where the error occurred, 5.

The third type of error is a **logic error**. If your program has a logic error, it will compile and run without generating error messages, but it will not do the right thing. Instead, it will do exactly what you told it to do. For example, here is a version of the hello world program with a logic error:

```
public class Hello {  
  
    public static void main(String[] args) {  
        System.out.println("Hello, ");  
        System.out.println("World!");  
    }  
}
```

This program compiles and runs just fine, but the output is:

```
Hello,  
World!
```

Assuming that we wanted the output on one line, this is not correct. The problem is that the first line uses `println`, when we probably meant to use `print` (see the “goodbye world” example of Section 1.5).

Identifying logic errors can be hard because you have to work backwards, looking at the output of the program, trying to figure out why it is doing the wrong thing, and how to make it do the right thing. Usually the compiler and the interpreter can’t help you, since they don’t know what the right thing is.

2.11 Vocabulary

variable: A named storage location for values. All variables have a type, which is declared when the variable is created.

value: A number, string, or other data that can be stored in a variable. Every value belongs to a type (for example, `int` or `String`).

type: Mathematically speaking, a set of values. The type of a variable determines which values it can have.

declaration: A statement that creates a new variable and specifies its type.

keyword: A reserved word used by the compiler to analyze programs. You cannot use keywords (like `public`, `class`, and `void`) as variable names.

assignment: A statement that gives a value to a variable.

initialize: To assign a variable for the first time.

state: The variables in a program and their current values.

memory diagram: A graphical representation of the state of a program at a point in time.

operator: A symbol that represents a computation like addition, multiplication, or string concatenation.

operand: One of the values on which an operator operates. Most operators in Java require two operands.

expression: A combination of variables, operators, and values that represents a single value. Expressions also have types, as determined by their operators and operands.

floating-point: A data type that represents numbers with an integer part and a fractional part. In Java, the default floating-point type is `double`.

rounding error: The difference between the number we want to represent and the nearest floating-point number.

concatenate: To join two values, often strings, end-to-end.

order of operations: The rules that determine in what order expressions are evaluated. Also known as “operator precedence”.

compile-time error: An error in the source code that makes it impossible to compile. Also called a “syntax error”.

parse: To analyze the structure of a program; what the compiler does first.

run-time error: An error in a program that makes it impossible to run to completion. Also called an “exception”.

logic error: An error in a program that makes it do something other than what the programmer intended.

2.12 Exercises

The code for this chapter is in the `ch02` directory of `ThinkJavaCode2`. See page xix for instructions on how to download the repository. Before you start the exercises, we recommend that you compile and run the examples.

If you have not already read Appendix A.2, now might be a good time. It describes the DrJava Interactions Pane, which is a useful way to develop and test short fragments of code without writing a complete class definition.

Exercise 2.1 If you are using this book in a class, you might enjoy this exercise. Find a partner and play “Stump the Chump”:

Start with a program that compiles and runs correctly. One player looks away while the other player adds an error to the program. Then the first player tries to find and fix the error. You get two points if you find the error without compiling the program, one point if you find it using the compiler, and your opponent gets a point if you don’t find it.

Exercise 2.2 The point of this exercise is (1) to use string concatenation to display values with different types (`int` and `String`), and (2) to practice developing programs gradually by adding a few statements at a time.

1. Create a new program named `Date.java`. Copy or type in something like the hello world program and make sure you can compile and run it.
2. Following the example in Section 2.4, write a program that creates variables named `day`, `date`, `month`, and `year`. The variable `day` will contain the day of the week (like Friday), and `date` will contain the day of the month (like the 13th). Assign values to those variables that represent today’s date.

3. Display the value of each variable on a line by itself. This is an intermediate step that is useful for checking that everything is working so far. Compile and run your program before moving on.
4. Modify the program so that it displays the date in standard American format, for example: `Thursday, July 16, 2015`.
5. Modify the program so it also displays the date in European format. The final output should be:

```
American format:  
Thursday, July 16, 2015  
European format:  
Thursday 16 July 2015
```

Exercise 2.3 The point of this exercise is to (1) use some of the arithmetic operators, and (2) start thinking about compound entities (like time of day) that are represented with multiple values.

1. Create a new program called `Time.java`. From now on, we won't remind you to start with a small, working program, but you should.
2. Following the example program in Section 2.4, create variables named `hour`, `minute`, and `second`. Assign values that are roughly the current time. Use a 24-hour clock so that at 2pm the value of `hour` is 14.
3. Make the program calculate and display the number of seconds since midnight.
4. Calculate and display the number of seconds remaining in the day.
5. Calculate and display the percentage of the day that has passed. You might run into problems when computing percentages with integers, so consider using floating-point.
6. Change the values of `hour`, `minute`, and `second` to reflect the current time. Then write code to compute the elapsed time since you started working on this exercise.

Hint: You might want to use additional variables to hold values during the computation. Variables that are used in a computation but never displayed are sometimes called “intermediate” or “temporary” variables.

Chapter 3

Input and Output

The programs we've looked at so far simply display messages, which doesn't really involve that much computation. This chapter will show you how to read input from the keyboard, use that input to calculate a result, and then format that result for output.

3.1 The System Class

We have been using `System.out.println` for a while, but you might not have thought about what it means. `System` is a class that provides methods related to the “system” or environment where programs run. It also provides `System.out`, which is a special value that has additional methods (like `println`) for displaying output.

In fact, we can use `System.out.println` to display the value of `System.out`:

```
System.out.println(System.out);
```

The result is:

```
java.io.PrintStream@685d72cd
```

This output indicates that `System.out` is a `PrintStream`, which is defined in a package called `java.io`. A **package** is a collection of related classes; `java.io` contains classes for “I/O” which stands for input and output.

The numbers and letters after the @ sign are the **address** of `System.out`, represented as a hexadecimal (base 16) number. The address of a value is its location in the computer's memory, which might be different on different computers. In this example the address is 685d72cd, but if you run the same code you will likely get something else.

As shown in Figure 3.1, `System` is defined in a file called `System.java`, and `PrintStream` is defined in `PrintStream.java`. These files are part of the Java **library**, which is an extensive collection of classes that you can use in your programs. The source code for these classes is usually included with the compiler (see Section 10.6).

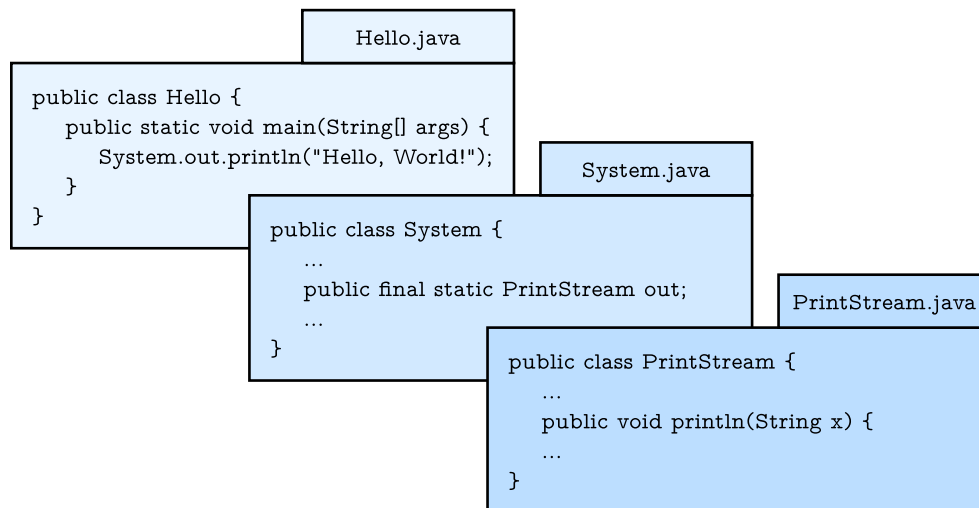

Figure 3.1: `System.out.println` refers to the `out` variable of the `System` class, which is a `PrintStream` that provides a method called `println`.

3.2 The Scanner Class

The `System` class also provides the special value `System.in`, which is an `InputStream` that has methods for reading input from the keyboard. These methods are not convenient to use, but fortunately Java provides other classes that make it easy to handle common input tasks.

For example, `Scanner` is a class that provides methods for inputting words, numbers, and other data. `Scanner` is provided by `java.util`, which is a

package that contains various “utility classes”. Before you can use `Scanner`, you have to import it like this:

```
import java.util.Scanner;
```

This **import statement** tells the compiler that when you refer to `Scanner`, you mean the one defined in `java.util`. Using an import statement is necessary because there might be another class named `Scanner` in another package.

Next you have to initialize the `Scanner`. This line declares a `Scanner` variable named `in` and creates a `Scanner` that reads input from `System.in`:

```
Scanner in = new Scanner(System.in);
```

The `Scanner` class provides a method called `nextLine` that reads a line of input from the keyboard and returns a `String`. Here’s a complete example that reads two lines and repeats them back to the user:

```
import java.util.Scanner;

public class Echo {

    public static void main(String[] args) {
        String line;
        Scanner in = new Scanner(System.in);

        System.out.print("Type something: ");
        line = in.nextLine();
        System.out.println("You said: " + line);

        System.out.print("Type something else: ");
        line = in.nextLine();
        System.out.println("You also said: " + line);
    }
}
```

Import statements can’t be inside a class definition. By convention, they are usually at the beginning of the file. If you omit the import statement, you get a compiler error like “cannot find symbol”. That means the compiler doesn’t know where to find the definition for `Scanner`.

You might wonder why we can use the `System` class without importing it. `System` belongs to the `java.lang` package, which is imported automatically. According to the documentation, `java.lang` “provides classes that are fundamental to the design of the Java programming language.” The `String` class is also part of `java.lang`.

3.3 Language Elements

At this point, we have seen nearly all of the organizational units that make up Java programs. Figure 3.2 shows how these “language elements” are related.

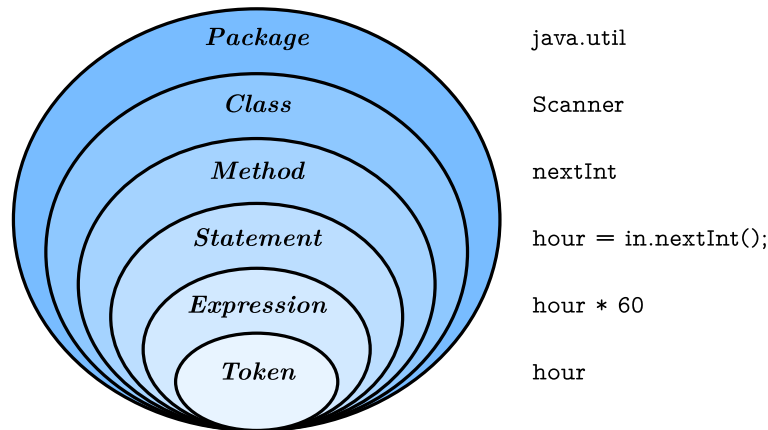

Figure 3.2: Elements of the Java language, from largest to smallest.

Java applications are typically organized into packages (like `java.io` and `java.util`) that include multiple classes (like `PrintStream` and `Scanner`). Each class defines its own methods (like `println` and `nextLine`), and each method is a sequence of statements.

Each statement performs one or more computations, depending on how many expressions it has, and each expression represents a single value to compute. For example, the assignment statement `hours = minutes / 60.0;` contains a single expression: `minutes / 60.0`.

Tokens are the most basic elements of a program, including numbers, variable names, operators, keywords, parentheses, braces, and semicolons. In the previous example, the tokens are `hours`, `=`, `minutes`, `/`, `60.0`, and `;` (spaces are ignored by the compiler).

Knowing this terminology is helpful, because error messages often say things like “not a statement” or “illegal start of expression” or “unexpected token”. Comparing Java to English, statements are complete sentences, expressions are phrases, and tokens are individual words and punctuation marks.

Note there is a big difference between the Java *language*, which defines the elements in Figure 3.2, and the Java *library*, which provides the built-in classes that you can import. For example, the keywords `public` and `class` are part of the Java language, but the names `PrintStream` and `Scanner` are not.

The standard edition of Java comes with *several thousand* classes you can use, which can be both exciting and intimidating. You can browse this library at <https://thinkjava.org/apidoc>. Interestingly, most of the Java library is written in Java.

3.4 Literals and Constants

Although most of the world has adopted the metric system for weights and measures, some countries are stuck with Imperial units. For example, when talking with friends in Europe about the weather, people in the United States might have to convert from Celsius to Fahrenheit and back. Or they might want to convert height in inches to centimeters.

We can write a program to help. We’ll use a `Scanner` to input a measurement in inches, convert to centimeters, and then display the results. The following lines declare the variables and create the `Scanner`:

```
int inch;  
double cm;  
Scanner in = new Scanner(System.in);
```

The next step is to prompt the user for the input. We’ll use `print` instead of `println` so they can enter the input on the same line as the **prompt**. And we’ll use the `Scanner` method `nextInt`, which reads input from the keyboard and converts it to an integer:

```
System.out.print("How many inches? ");  
inch = in.nextInt();
```

Next we multiply the number of inches by 2.54, since that's how many centimeters there are per inch, and display the results:

```
cm = inch * 2.54;
System.out.print(inch + " in = ");
System.out.println(cm + " cm");
```

This code works correctly, but it has a minor problem. If another programmer reads this code, they might wonder where 2.54 comes from. For the benefit of others (and yourself in the future), it would be better to assign this value to a variable with a meaningful name.

A value that appears in a program, like the number 2.54, is called a **literal**. In general, there's nothing wrong with literals. But when numbers like 2.54 appear in an expression with no explanation, they make the code hard to read. And if the same value appears many times and could change in the future, it makes the code hard to maintain.

Values like 2.54 are sometimes called **magic numbers** (with the implication that being “magic” is not a good thing). A good practice is to assign magic numbers to variables with meaningful names, like this:

```
double cmPerInch = 2.54;
cm = inch * cmPerInch;
```

This version is easier to read and less error-prone, but it still has a problem. Variables can vary (hence the term), but the number of centimeters in an inch does not. Once we assign a value to `cmPerInch`, it should never change. Java provides the keyword `final`, a language feature that enforces this rule.

```
final double CM_PER_INCH = 2.54;
```

Declaring that a variable is `final` means that it cannot be reassigned once it has been initialized. If you try, the compiler gives an error.

Variables declared as `final` are called **constants**. By convention, names for constants are all uppercase, with the underscore character (`_`) between words.

3.5 Formatting Output

When you output a `double` using `print` or `println`, it displays up to 16 decimal places:

```
System.out.print(4.0 / 3.0);
```

The result is:

```
1.3333333333333333
```

That might be more than you want. `System.out` provides another method, called `printf`, that gives you more control of the format. The “f” in `printf` stands for “formatted”. Here’s an example:

```
System.out.printf("Four thirds = %.3f", 4.0 / 3.0);
```

The first value in the parentheses is a **format string** that specifies how the output should be displayed. This format string contains ordinary text followed by a **format specifier**, which is a special sequence that starts with a percent sign. The format specifier `%.3f` indicates that the following value should be displayed as floating-point, rounded to three decimal places. The result is:

```
Four thirds = 1.333
```

The format string can contain any number of format specifiers; here’s an example with two of them:

```
int inch = 100;  
double cm = inch * CM_PER_INCH;  
System.out.printf("%d in = %f cm\n", inch, cm);
```

The result is:

```
100 in = 254.000000 cm
```

Like `print`, `printf` does not append a newline. So format strings often end with a newline character.

The format specifier `%d` displays integer values (“d” stands for “decimal”, meaning base 10 integer). The values are matched up with the format specifiers in order, so `inch` is displayed using `%d`, and `cm` is displayed using `%f`.

Learning about format strings is like learning a sub-language within Java. There are many options, and the details can be overwhelming. Table 3.1 lists a few common uses, to give you an idea of how things work.

<code>%d</code>	integer in base 10 (“decimal”)	12345
<code>%,d</code>	integer with comma separators	12,345
<code>%08d</code>	padded with zeros, at least 8 digits wide	00012345
<code>%f</code>	floating-point number	6.789000
<code>%.2f</code>	rounded to 2 decimal places	6.79
<code>%s</code>	string of characters	"Hello"
<code>%x</code>	integer in base 16 (“hexadecimal”)	bc614e

Table 3.1: Example format specifiers

For more details, refer to the documentation of `java.util.Formatter`. The easiest way to find documentation for Java classes is to do a web search for “Java” and the name of the class.

3.6 Reading Error Messages

Notice that the values you pass to `printf` are separated by commas. If you are used to using the `+` operator to concatenate strings, you might write something like this by accident:

```
System.out.printf("inches = %d" + inch); // error
```

This line of code is legal, so the compiler won’t catch the mistake. Instead, when you run the program, it causes an exception:

```
Exception in thread "main" java.util.MissingFormatArgumentException:
Format specifier '%d'
  at java.util.Formatter.format(Formatter.java:2519)
  at java.io.PrintStream.format(PrintStream.java:970)
  at java.io.PrintStream.printf(PrintStream.java:871)
  at Example.main(Example.java:10)
```

As we saw in Section 2.10, the error message includes the name of the exception, `MissingFormatArgumentException`, followed by additional details, `Format specifier '%d'`. That means it doesn't know what value to substitute for `%d`.

The problem is that concatenation happens first, before `printf` executes. If the value of `inch` is 100, the result of concatenation is `"inches = %d100"`. So `printf` gets the format string, but it doesn't get any values to format.

The error message also includes a **stack trace** that shows the method that was running when the error was detected, `java.util.Formatter.format`, the method that called it, `java.io.PrintStream.format`, the method that called *that*, `java.io.PrintStream.printf`, and finally the method you actually wrote, `Example.main`.

Each line also names the source file of the method and the line it was on (e.g., `Example.java:10`). That's a lot of information, and it includes method names and file names you have no reason to know at this point. But don't be overwhelmed.

When you see an error message like this, read the first line carefully to see *what* happened. Then read the last line to see *where* it happened. In some IDEs, you can click on the error message and it will take you to the line of code that was running. But remember that where the error is discovered is not always where it was caused.

3.7 Type Cast Operators

Now suppose we have a measurement in centimeters, and we want to round it off to the nearest inch. It is tempting to write:

```
inch = cm / CM_PER_INCH; // syntax error
```

But the result is an error – you get something like, “incompatible types: possible lossy conversion from double to int.” The problem is that the value on the right is floating-point, and the variable on the left is an integer.

Java converts an `int` to a `double` automatically, since no information is lost in the process. On the other hand, going from `double` to `int` would lose the

decimal places. Java doesn't perform this operation automatically in order to ensure that you are aware of the loss of the fractional part of the number.

The simplest way to convert a floating-point value to an integer is to use a **type cast**, so called because it molds or “casts” a value from one type to another. The syntax for type casting is to put the name of the type in parentheses and use it as an operator.

```
double pi = 3.14159;
int x = (int) pi;
```

The `(int)` operator has the effect of converting what follows into an integer. In this example, `x` gets the value 3. Like integer division, casting to an integer always rounds toward zero, even if the fractional part is 0.999999 (or -0.999999). In other words, it simply throws away the fractional part.

In order to use a cast operator, the types must be compatible. For example, you can't cast a `String` to an `int` because a string is not a number.

```
String str = "3";
int x = (int) str; // error: incompatible types
```

Type casting takes precedence over arithmetic operations. In the following example, the value of `pi` gets converted to an integer before the multiplication.

```
double pi = 3.14159;
double x = (int) pi * 20.0; // result is 60.0, not 62.0
```

Keeping that in mind, here's how we can convert centimeters to inches:

```
inch = (int) (cm / CM_PER_INCH);
System.out.printf("%f cm = %d in\n", cent, inch);
```

The parentheses after the cast operator require the division to happen before the type cast. And the result is rounded toward zero. We will see in the next chapter how to round floating-point numbers to the closest integer.

3.8 Remainder Operator

Let's take the example one step further: suppose you have a measurement in inches and you want to convert to feet and inches. The goal is divide by 12 (the number of inches in a foot) and keep the remainder.

We have already seen the division operation ($/$), which computes the quotient of two numbers. If the numbers are integers, it performs integer division. Java also provides the **modulo** operation ($\%$), which divides two numbers and computes the remainder.

Using division and modulo, we can convert to feet and inches like this:

```
feet = 76 / 12;    // quotient
inches = 76 % 12; // remainder
```

The first line yields 6. The second line, which is pronounced “76 mod 12”, yields 4. So 76 inches is 6 feet, 4 inches.

Many people (and textbooks) incorrectly refer to $\%$ as the “modulus operator”. In mathematics, however, **modulus** is the number you’re dividing by. In the previous example, the modulus is 12.

The Java language specification refers to $\%$ as the “remainder operator”. The remainder operator looks like a percent sign, but you might find it helpful to think of it as a division sign (\div) rotated to the left.

Modular arithmetic turns out to be surprisingly useful. For example, you can check whether one number is divisible by another: if $x \% y$ is zero, then x is divisible by y . You can use remainder to “extract” digits from a number: $x \% 10$ yields the rightmost digit of x , and $x \% 100$ yields the last two digits. And many encryption algorithms use the remainder operator extensively.

3.9 Putting It All Together

At this point, you have seen enough Java to write useful programs that solve everyday problems. You can (1) import Java library classes, (2) create a **Scanner**, (3) get input from the keyboard, (4) format output with **printf**, and (5) divide and mod integers. Now we will put everything together in a complete program:

```
import java.util.Scanner;

/**
 * Converts centimeters to feet and inches.
 */
public class Convert {

    public static void main(String[] args) {
        double cm;
        int feet, inches, remainder;
        final double CM_PER_INCH = 2.54;
        final int IN_PER_FOOT = 12;
        Scanner in = new Scanner(System.in);

        // prompt the user and get the value
        System.out.print("Exactly how many cm? ");
        cm = in.nextDouble();

        // convert and output the result
        inches = (int) (cm / CM_PER_INCH);
        feet = inches / IN_PER_FOOT;
        remainder = inches % IN_PER_FOOT;
        System.out.printf("%.2f cm = %d ft, %d in\n",
                           cm, feet, remainder);
    }
}
```

Although not required, all variables and constants are declared at the top of `main`. This practice makes it easier to find their types later on, and it helps the reader know what data is involved in the algorithm.

For readability, each major step of the algorithm is separated by a blank line and begins with a comment. The class also includes a documentation comment (`/**`), which you can learn more about in Appendix B.

Many algorithms, including the `Convert` program, perform division and modulo together. In both steps, you divide by the same number (`IN_PER_FOOT`).

When statements including `System.out.printf` get long (generally wider

than 80 characters), a common style convention is to break them across multiple lines. The reader should never have to scroll horizontally.

3.10 The Scanner Bug

Now that you've had some experience with `Scanner`, there is an unexpected behavior we want to warn you about. The following code fragment asks users for their name and age:

```
System.out.print("What is your name? ");
name = in.nextLine();
System.out.print("What is your age? ");
age = in.nextInt();
System.out.printf("Hello %s, age %d\n", name, age);
```

The output might look something like this:

```
Hello Grace Hopper, age 45
```

When you read a `String` followed by an `int`, everything works just fine. But when you read an `int` followed by a `String`, something strange happens.

```
System.out.print("What is your age? ");
age = in.nextInt();
System.out.print("What is your name? ");
name = in.nextLine();
System.out.printf("Hello %s, age %d\n", name, age);
```

Try running this example code. It doesn't let you input your name, and it immediately displays the output:

```
What is your name? Hello , age 45
```

To understand what is happening, you need to realize that `Scanner` doesn't see input as multiple lines like we do. Instead, it gets a "stream of characters" as shown in Figure 3.3.

The arrow indicates the next character to be read by `Scanner`. When you call `nextInt`, it reads characters until it gets to a non-digit. Figure 3.4 shows the state of the stream after `nextInt` is called.

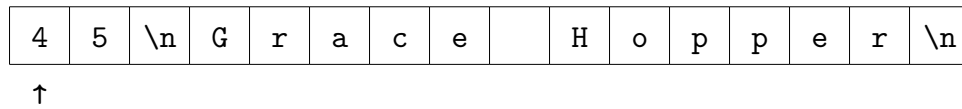
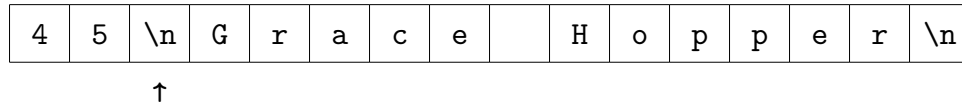

Figure 3.3: A stream of characters as seen by a Scanner.

Figure 3.4: A stream of characters after `nextInt` is called.

At this point, `nextInt` returns 45. The program then displays the prompt `"What is your name? "` and calls `nextLine`, which reads characters until it gets to a newline. But since the next character is already a newline, `nextLine` returns the empty string `""`.

To solve this problem, you need an extra `nextLine` after `nextInt`.

```
System.out.print("What is your age? ");
age = in.nextInt();
in.nextLine(); // read the newline
System.out.print("What is your name? ");
name = in.nextLine();
System.out.printf("Hello %s, age %d\n", name, age);
```

This technique is common when reading `int` or `double` values that appear on their own line. First you read the number, and then you read the rest of the line, which is just a newline character.

3.11 Vocabulary

package: A directory of classes that are related to each other.

address: The location of a value in computer memory, often represented as a hexadecimal integer.

library: A collection of packages and classes that are available for use in other programs.

import statement: A statement that allows programs to use classes defined in other packages.

token: The smallest unit of source code, such as an individual word, literal value, or symbol.

literal: A value that appears in source code. For example, "Hello" is a string literal, and 74 is an integer literal.

prompt: A brief message displayed in a print statement that asks the user for input.

magic number: A number that appears without explanation as part of an expression. It should generally be replaced with a constant.

constant: A variable, declared as `final`, whose value cannot be changed.

format string: The string in `System.out.printf` that specifies the format of the output.

format specifier: A special code that begins with a percent sign and specifies the data type and format of the corresponding value.

stack trace: An error message that shows the methods that were running when an exception occurs.

type cast: An operation that explicitly converts one data type into another. In Java it appears as a type name in parentheses, like `(int)`.

modulo: An operation that yields the remainder when one integer is divided by another. In Java, it is denoted with a percent sign: `5 % 2` is 1.

modulus: The value of `b` in the expression `a % b`. It often represents unit conversions, such as 24 hours in a day, 60 minutes in an hour, etc.

3.12 Exercises

The code for this chapter is in the `ch03` directory of `ThinkJavaCode2`. See page xix for instructions on how to download the repository. Before you start the exercises, we recommend that you compile and run the examples.

If you have not already read Appendix A.3, now might be a good time. It describes the command-line interface, which is a powerful and efficient way to interact with your computer.

Exercise 3.1 When you use `printf`, the Java compiler does not check your format string. See what happens if you try to display a value with type `int` using `%f`. And what happens if you display a `double` using `%d`? What if you use two format specifiers, but then only provide one value?

Exercise 3.2 Write a program that converts a temperature from Celsius to Fahrenheit. It should (1) prompt the user for input, (2) read a `double` value from the keyboard, (3) calculate the result, and (4) format the output to one decimal place.

When it's finished, it should work like this:

```
Enter a temperature in Celsius: 24
24.0 C = 75.2 F
```

Here is the formula to do the conversion:

$$F = C \times \frac{9}{5} + 32$$

HINT: Be careful not to use integer division!

Exercise 3.3 Write a program that converts a total number of seconds to hours, minutes, and seconds. It should (1) prompt the user for input, (2) read an integer from the keyboard, (3) calculate the result, and (4) use `printf` to display the output. For example, "5000 seconds = 1 hours, 23 minutes, and 20 seconds".

Hint: Use the remainder operator.

Exercise 3.4 The goal of this exercise is to program a "Guess My Number" game. When it's finished, it should work like this:

```
I'm thinking of a number between 1 and 100
(including both). Can you guess what it is?
Type a number: 45
Your guess is: 45
The number I was thinking of is: 14
You were off by: 31
```

To choose a random number, you can use the `Random` class in `java.util`. Here's how it works:

```
import java.util.Random;

public class GuessStarter {

    public static void main(String[] args) {
        // pick a random number
        Random random = new Random();
        int number = random.nextInt(100) + 1;
        System.out.println(number);
    }
}
```

Like the `Scanner` class we saw in this chapter, `Random` has to be imported before we can use it. And as we saw with `Scanner`, we have to use the `new` operator to create a `Random` (number generator).

Then we can use the method `nextInt` to generate a random number. In this example, the result of `nextInt(100)` will be between 0 and 99, including both. Adding 1 yields a number between 1 and 100, including both.

1. The definition of `GuessStarter` is in a file called `GuessStarter.java`, in the directory called `ch03`, in the repository for this book.
2. Compile and run this program.
3. Modify the program to prompt the user, then use a `Scanner` to read a line of user input. Compile and test the program.
4. Read the user input as an integer and display the result. Again, compile and test.
5. Compute and display the difference between the user's guess and the number that was generated.

Chapter 4

Methods and Testing

So far we've written programs that have only one method named `main`. In this chapter, we'll show you how to organize programs into multiple methods. We'll also take a look at the `Math` class, which provides methods for common mathematical operations. Finally, we'll discuss strategies for incrementally developing and testing your code.

4.1 Defining New Methods

Some methods perform a computation and return a result. For example, `nextDouble` reads input from the keyboard and returns it as a `double`. Other methods, like `println`, carry out a sequence of actions without returning a result. Java uses the keyword `void` to define such methods.

```
public static void newLine() {
    System.out.println();
}

public static void main(String[] args) {
    System.out.println("First line.");
    newLine();
    System.out.println("Second line.");
}
```

In this example, the `newLine` and `main` methods are both `public`, which means they can be **invoked** (or called) from other classes. And they are both `void`, which means that they don't return a result (in contrast to `nextDouble`). The output of the program is:

```
First line.
```

```
Second line.
```

Notice the extra space between the lines. If we wanted more space between them, we could invoke the same method repeatedly. Or we could write yet another method (named `threeLine`) that displays three blank lines.

```
public class NewLine {  
  
    public static void newLine() {  
        System.out.println();  
    }  
  
    public static void threeLine() {  
        newLine();  
        newLine();  
        newLine();  
    }  
  
    public static void main(String[] args) {  
        System.out.println("First line.");  
        threeLine();  
        System.out.println("Second line.");  
    }  
}
```

In this example, the name of the class is `NewLine`. By convention, class names begin with a capital letter. `NewLine` contains three methods, `newLine`, `threeLine`, and `main`. Remember that Java is case-sensitive, so `NewLine` and `newLine` are not the same.

By convention, method names begin with a lowercase letter and use “camel case”, which is a cute name for `jammingWordsTogetherLikeThis`. You can use any name you want for methods, except `main` or any of the Java keywords.

4.2 Flow of Execution

When you look at a class definition that contains several methods, it is tempting to read it from top to bottom. But that is *not* the **flow of execution**, or the order the program actually runs. The `NewLine` program runs methods in the opposite order than they are listed.

Programs always begin at the first statement of `main`, regardless of where it is in the source file. Statements are executed one at a time, in order, until you reach a method invocation, which you can think of as a detour. Instead of going to the next statement, you jump to the first line of the invoked method, execute all the statements there, and then come back and pick up exactly where you left off.

That sounds simple enough, but remember that one method can invoke another one. In the middle of `main`, the previous example goes off to execute the statements in `threeLine`. While in `threeLine`, it goes off to execute `newLine`. Then `newLine` invokes `println`, which causes yet another detour.

Fortunately, Java is good at keeping track of which methods are running. So when `println` completes, it picks up where it left off in `newLine`; when `newLine` completes, it goes back to `threeLine`; and when `threeLine` completes, it gets back to `main`.

Beginners often wonder why it's worth the trouble to write other methods, when they could just do everything in `main`. The `NewLine` example demonstrates a few reasons:

- Creating a new method allows you to *name a block of statements*, which makes the code easier to read and understand.
- Introducing new methods can *make the program shorter* by eliminating repetitive code. For example, to display nine consecutive newlines, you could invoke `threeLine` three times.
- A common problem-solving technique is to *break problems down* into sub-problems. Methods allow you to focus on each sub-problem in isolation, and then compose them into a complete solution.

Perhaps most importantly, organizing your code into multiple methods allows you to test individual parts of your program separately. It's easier to get a complex program working if you know that each method works correctly.

4.3 Parameters and Arguments

Some of the methods we have used require **arguments**, which are the values you provide in parentheses when you invoke the method.

For example, the `println` method takes a `String` argument. To display a message, you have to provide the message: `System.out.println("Hello")`. Similarly, the `printf` method can take multiple arguments. The statement `System.out.printf("%d in = %f cm\n", inch, cm)` has three arguments: the format string, the `inch` value, and the `cm` value.

When you invoke a method, you provide the arguments. When you define a method, you name the **parameters**, which are variables that indicate what arguments are required. The following class shows an example:

```
public class PrintTwice {  
  
    public static void printTwice(String s) {  
        System.out.println(s);  
        System.out.println(s);  
    }  
  
    public static void main(String[] args) {  
        printTwice("Don't make me say this twice!");  
    }  
}
```

The `printTwice` method has a parameter named `s` with type `String`. When you invoke `printTwice`, you have to provide an argument with type `String`.

Before the method executes, the argument gets assigned to the parameter. In the `printTwice` example, the argument `"Don't make me say this twice!"` gets assigned to the parameter `s`.

This process is called **parameter passing**, because the value gets passed from outside the method to the inside. An argument can be any kind of expression, so if you have a `String` variable, you can use its value as an argument:

```
String message = "Never say never."  
printTwice(message);
```

The value you provide as an argument must have the same (or compatible) type as the parameter. For example, if you try:

```
printTwice(17); // syntax error
```

You will get an error message like this:

```
File: Test.java [line: 10]
Error: method printTwice in class Test cannot be applied
      to given types;
      required: java.lang.String
      found: int
      reason: actual argument int cannot be converted to
              java.lang.String by method invocation conversion
```

This error message says that it found an `int` argument, but the required parameter should be a `String`. In the case of `printTwice`, Java won't convert the integer 17 to the string `"17"` automatically.

Sometimes Java can convert an argument from one type to another automatically. For example, `Math.sqrt` requires a `double`, but if you invoke `Math.sqrt(25)`, the integer value 25 is automatically converted to the floating-point value 25.0.

Parameters and other variables only exist inside their own methods. In the `printTwice` example, there is no such thing as `s` in the `main` method. If you try to use it there, you'll get a compiler error.

Similarly, inside `printTwice` there is no such thing as `message`. That variable belongs to `main`. Because variables only exist inside the methods where they are defined, they are often called **local variables**.

4.4 Multiple Parameters

Here is an example of a method that takes two parameters:

```
public static void printTime(int hour, int minute) {
    System.out.print(hour);
    System.out.print(":");
    System.out.println(minute);
}
```

To invoke this method, we have to provide two integers as arguments:

```
int hour = 11;
int minute = 59;
printTime(hour, minute);
```

Beginners sometimes make the mistake of “declaring” the arguments:

```
int hour = 11;
int minute = 59;
printTime(int hour, int minute); // syntax error
```

That’s a syntax error, because the compiler sees `int hour` and `int minute` as variable declarations, not expressions that represent values. You wouldn’t declare the types of the arguments if they were simply integers:

```
printTime(int 11, int 59); // syntax error
```

Pulling together the code fragments, here is the complete program:

```
public class PrintTime {

    public static void printTime(int hour, int minute) {
        System.out.print(hour);
        System.out.print(":");
        System.out.println(minute);
    }

    public static void main(String[] args) {
        int hour = 11;
        int minute = 59;
        printTime(hour, minute);
    }
}
```

`printTime` has two parameters, named `hour` and `minute`. And `main` has two variables, also named `hour` and `minute`. Although they have the same names, these variables are *not* the same. The `hour` in `printTime` and the `hour` in `main` refer to different memory locations, and they can have different values. For example, you could invoke `printTime` like this:

```
int hour = 11;
int minute = 59;
printTime(hour + 1, 0);
```

Before the method is invoked, Java evaluates the arguments; in this example, the results are 12 and 0. Then it assigns those values to the parameters. Inside `printTime`, the value of `hour` is 12, not 11, and the value of `minute` is 0, not 59. Furthermore, if `printTime` modifies one of its parameters, that change has no effect on the variables in `main`.

4.5 Stack Diagrams

One way to keep track of variables is to draw a **stack diagram**, which is a memory diagram (see Section 2.3) that shows currently running methods. For each method there is a box, called a **frame**, that contains the method's parameters and local variables. The name of the method appears outside the frame; the variables and parameters appear inside.

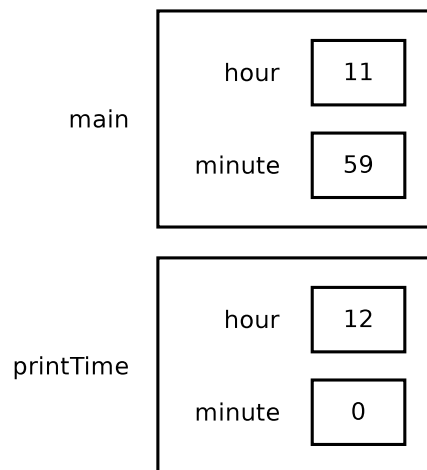

Figure 4.1: Stack diagram for `printTime(hour + 1, 0)`.

As with memory diagrams, stack diagrams show variables and methods at a particular point in time. Figure 4.1 is a stack diagram at the beginning of the `printTime` method. Notice that `main` is on top, because it executed first.

Stack diagrams help you to visualize the **scope** of a variable, which is the area of a program where a variable can be used.

Stack diagrams are a good mental model for how variables and methods work at run-time. Learning to trace the execution of a program on paper (or on a whiteboard) is a useful skill for communicating with other programmers.

There are educational tools that automatically draw stack diagrams for you. For example, Java Tutor (<https://thinkjava.org/javatutor>) allows you to step through an entire program, both forwards and backwards, and see the stack frames and variables at each step. If you haven't already, you should check out the Java examples on that website.

4.6 Math Methods

You don't always have to write new methods to get work done. As a reminder, the Java library contains thousands of classes you can use. For example, the `Math` class provides common mathematical operations.

```
double root = Math.sqrt(17.0);
double angle = 1.5;
double height = Math.sin(angle);
```

The first line sets `root` to the square root of 17. The third line finds the sine of 1.5 (the value of `angle`). `Math` is in the `java.lang` package, so you don't have to import it.

Values for the trigonometric functions – `sin`, `cos`, and `tan` – must be in *radians*. To convert from degrees to radians, you can divide by 180 and multiply by π . Conveniently, the `Math` class provides a constant named `PI` that contains an approximation of π :

```
double degrees = 90;
double angle = degrees / 180.0 * Math.PI;
```

Notice that `PI` is in capital letters. Java does not recognize `Pi`, `pi`, or `pie`. Also, `PI` is the name of a constant, not a method, so it doesn't have parentheses. The same is true for the constant `Math.E`, which approximates Euler's number.

Converting to and from radians is a common operation, so the `Math` class provides methods that do that for you.

```
double radians = Math.toRadians(180.0);  
double degrees = Math.toDegrees(Math.PI);
```

Another useful method is `round`, which rounds a floating-point value to the nearest integer and returns a `long`. The following result is 63 (rounded up from 62.8319).

```
long x = Math.round(Math.PI * 20.0);
```

A `long` is like an `int`, but bigger. More specifically, an `int` uses 32 bits of memory; the largest value it can hold is $2^{31} - 1$, which is about 2 billion. A `long` uses 64 bits, so the largest value is $2^{63} - 1$, which is about 9 quintillion.

Take a minute to read the documentation for these and other methods in the `Math` class. The easiest way to find documentation for Java classes is to do a web search for “Java” and the name of the class.

4.7 Composition

You have probably learned how to evaluate simple expressions like $\sin(\pi/2)$ and $\log(1/x)$. First, you evaluate the expression in parentheses, which is the argument of the function. Then you can evaluate the function itself, either by hand or by punching it into a calculator.

This process can be applied repeatedly to evaluate more complex expressions like $\log(1/\sin(\pi/2))$. First we evaluate the argument of the innermost function ($\pi/2 = 1.57$), then evaluate the function itself ($\sin(1.57) = 1.0$), and so on.

Just as with mathematical functions, Java methods can be **composed** to solve complex problems. That means you can use one method as part of another. In fact, you can use any expression as an argument to a method, as long as the resulting value has the correct type:

```
double x = Math.cos(angle + Math.PI / 2.0);
```

This statement divides `Math.PI` by two, adds the result to `angle`, and computes the cosine of the sum. You can also take the result of one method and pass it as an argument to another:

```
double x = Math.exp(Math.log(10.0));
```

In Java, the `log` method always uses base e . So this statement finds the log base e of 10, and then raises e to that power. The result gets assigned to `x`.

Some math methods take more than one argument. For example, `Math.pow` takes two arguments and raises the first to the power of the second. This line computes 2^{10} and assigns the value 1024.0 to the variable `x`:

```
double x = Math.pow(2.0, 10.0);
```

When using `Math` methods, beginners often forget the word `Math`. For example, if you just write `x = pow(2.0, 10.0)`, you will get a compiler error:

```
File: Test.java [line: 5]
Error: cannot find symbol
  symbol:   method pow(double,double)
  location: class Test
```

The message “cannot find symbol” is confusing, but the last two lines provide a useful hint. The compiler is looking for a method named `pow` in the file `Test.java` (the file for this example). If you don’t specify a class name when referring to a method, the compiler looks in the current class by default.

4.8 Return Values

When you invoke a `void` method, the invocation is usually on a line all by itself. For example:

```
printTime(hour + 1, 0);
```

On the other hand, when you invoke a value-returning method, you have to do something with the return value. We usually assign it to a variable or use it as part of an expression, like this:

```
double error = Math.abs(expect - actual);
double height = radius * Math.sin(angle);
```

Compared to `void` methods, value-returning methods differ in two ways:

- They declare the type of the return value (the **return type**);
- They use at least one **return** statement to provide a **return value**.

Here's an example from a program named `Circle.java`. The `calculateArea` method takes a `double` as a parameter and returns the area of a circle with that radius (i.e., πr^2).

```
public static double calculateArea(double radius) {  
    double result = Math.PI * radius * radius;  
    return result;  
}
```

As usual, this method is `public` and `static`. But in the place where we are used to seeing `void`, we see `double`, which means that the return value from this method is a `double`.

The last line is a new form of the `return` statement that means, “return immediately from this method, and use the following expression as the return value.” The expression you provide can be arbitrarily complex, so we could have written this method more concisely:

```
public static double calculateArea(double radius) {  
    return Math.PI * radius * radius;  
}
```

On the other hand, **temporary variables** like `result` often make debugging easier, especially when you are stepping through code using an interactive debugger (see Appendix A.6).

Figure 4.2 illustrates how data values flows through the program. When the `main` method invokes `calculateArea`, the value `5.0` is assigned to the parameter `radius`. `calculateArea` then returns the value `78.54`, which is assigned to the variable `area`.

The type of the expression in the `return` statement must match the return type of the method itself. When you declare that the return type is `double`, you are making a promise that this method will eventually produce a `double` value. If you try to `return` with no expression, or `return` an expression with the wrong type, the compiler will give an error.

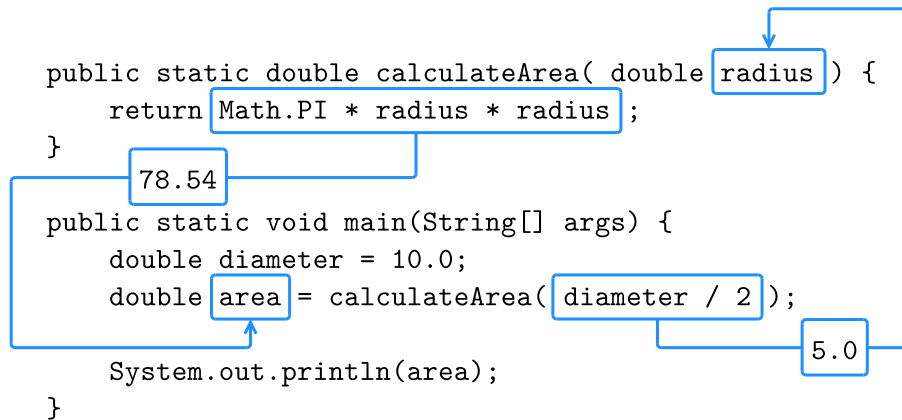

Figure 4.2: Passing a parameter and saving the return value.

4.9 Incremental Development

People often make the mistake of writing a lot of code before they try to compile and run it. Then they spend way too much time debugging. A better approach is what we call **incremental development**. The key aspects of incremental development are:

- Start with a working program and make small, incremental changes. At any point, if there is an error, you will know where to look.
- Use variables to hold intermediate values so you can check them, either with print statements or by using a debugger.
- Once the program is working, you can consolidate multiple statements into compound expressions (but only if it does not make the program more difficult to read).

As an example, suppose you want to find the distance between two points, given by the coordinates (x_1, y_1) and (x_2, y_2) . By the usual definition:

$$distance = \sqrt{(x_2 - x_1)^2 + (y_2 - y_1)^2}$$

The first step is to consider what a **distance** method should look like in Java. In other words, what are the inputs (parameters) and what is the output

(return value)? For this method, the parameters are the two points, and it is natural to represent them using four `double` values. The return value is the distance, which should also have type `double`.

Already we can write an outline for the method, which is sometimes called a **stub**. The stub includes the method declaration and a `return` statement:

```
public static double distance
    (double x1, double y1, double x2, double y2) {
    return 0.0; // stub
}
```

The return statement is a placeholder that is only necessary for the program to compile. At this stage the program doesn't do anything useful, but it is good to compile it so we can find any syntax errors before we add more code.

It's usually a good idea to think about testing *before* you develop new methods; doing so can help you figure out how to implement them. To test the method, we can invoke it from `main` using the sample values:

```
double dist = distance(1.0, 2.0, 4.0, 6.0);
```

With these values, the horizontal distance is 3.0 and the vertical distance is 4.0. So the result should be 5.0, the hypotenuse of a 3-4-5 triangle. When you are testing a method, it is necessary to know the right answer.

Once we have compiled the stub, we can start adding code one line at a time. After each incremental change, we recompile and run the program. If there is an error, we have a good idea where to look: the lines we just added.

The next step is to find the differences $x_2 - x_1$ and $y_2 - y_1$. We store those values in temporary variables named `dx` and `dy`, so that we can examine them with print statements before proceeding. They should be 3.0 and 4.0.

```
public static double distance
    (double x1, double y1, double x2, double y2) {
    double dx = x2 - x1;
    double dy = y2 - y1;
    System.out.println("dx is " + dx);
    System.out.println("dy is " + dy);
    return 0.0; // stub
}
```

We will remove the print statements when the method is finished. Code like that is called **scaffolding**, because it is helpful for building the program, but it is not part of the final product.

The next step is to square `dx` and `dy`. We could use the `Math.pow` method, but it is simpler (and more efficient) to multiply each term by itself.

Then we add the squares and print the result so far.

```
public static double distance
    (double x1, double y1, double x2, double y2) {
    double dx = x2 - x1;
    double dy = y2 - y1;
    double dsquared = dx * dx + dy * dy;
    System.out.println("dsquared is " + dsquared);
    return 0.0; // stub
}
```

Again, you should compile and run the program at this stage and check the intermediate value, which should be 25.0. Finally, we can use `Math.sqrt` to compute and return the result.

```
public static double distance
    (double x1, double y1, double x2, double y2) {
    double dx = x2 - x1;
    double dy = y2 - y1;
    double dsquared = dx * dx + dy * dy;
    double result = Math.sqrt(dsquared);
    return result;
}
```

As you gain more experience programming, you might write and debug more than one line at a time. But if you find yourself spending a lot of time debugging, consider taking smaller steps.

4.10 Vocabulary

void: A special return type indicating the method does not return a value.

- invoke:** To cause a method to execute. Also known as “calling” a method.
- flow of execution:** The order in which Java executes methods and statements. It may not necessarily be from top to bottom in the source file.
- argument:** A value that you provide when you call a method. This value must have the type that the method expects.
- parameter:** A piece of information that a method requires before it can run. Parameters are variables: they contain values and have types.
- parameter passing:** The process of assigning an argument value to a parameter variable.
- local variable:** A variable declared inside a method. Local variables cannot be accessed from outside their method.
- stack diagram:** A graphical representation of the variables belonging to each method. The method calls are “stacked” from top to bottom, in the flow of execution.
- frame:** In a stack diagram, a representation of the variables and parameters for a method, along with their current values.
- scope:** The area of a program where a variable can be used.
- composition:** The ability to combine simple expressions and statements into compound expressions and statements.
- return type:** The type of value a method returns.
- return value:** The value provided as the result of a method invocation.
- temporary variable:** A short-lived variable, often used for debugging.
- incremental development:** A process for creating programs by writing a few lines at a time, compiling, and testing.
- stub:** A placeholder for an incomplete method so that the class will compile.
- scaffolding:** Code that is used during program development but is not part of the final version.

4.11 Exercises

The code for this chapter is in the `ch04` directory of `ThinkJavaCode2`. See page xix for instructions on how to download the repository. Before you start the exercises, we recommend that you compile and run the examples.

If you have not already read Appendix A.4, now might be a good time. It describes an efficient way to test programs that take input from the user and display specific output.

Exercise 4.1 The purpose of this exercise is to take code from a previous exercise and redesign it as a method that takes parameters. You should start with a working solution to Exercise 2.2.

1. Write a method called `printAmerican` that takes the day, date, month and year as parameters and that displays them in American format.
2. Test your method by invoking it from `main` and passing appropriate arguments. The output should look something like this (except that the date might be different):

```
Saturday, July 22, 2015
```

3. Once you have debugged `printAmerican`, write another method called `printEuropean` that displays the date in European format.

Exercise 4.2 This exercise reviews the flow of execution through a program with multiple methods. Read the following code and answer the questions.

```
public static void main(String[] args) {  
    zippo("rattle", 13);  
}
```

```
public static void baffle(String blimp) {  
    System.out.println(blimp);  
    zippo("ping", -5);  
}
```



```
public static void zippo(String quince, int flag) {
    if (flag < 0) {
        System.out.println(quince + " zoop");
    } else {
        System.out.println("ik");
        baffle(quince);
        System.out.println("boo-wa-ha-ha");
    }
}
```

1. Write the number 1 next to the first line of code in this program that will execute.
2. Write the number 2 next to the second line of code, and so on until the end of the program. If a line is executed more than once, it might end up with more than one number next to it.
3. What is the value of the parameter `blimp` when `baffle` gets invoked?
4. What is the output of this program?

Exercise 4.3 Answer the following questions without running the program on a computer.

1. Draw a stack diagram that shows the state of the program the first time `ping` is invoked.
2. What is output by the following program? Be precise about where there are spaces and where there are newlines.

```
public static void zoop() {
    baffle();
    System.out.print("You wugga ");
    baffle();
}
```

```
public static void main(String[] args) {
    System.out.print("No, I ");
    zoop();
    System.out.print("I ");
    baffle();
}
```

```
public static void baffle() {
    System.out.print("wug");
    ping();
}
```

```
public static void ping() {
    System.out.println(".");
}
```

Exercise 4.4 If you have a question about whether something is legal, and what happens if it is not, a good way to find out is to ask the compiler. Answer the following questions by trying them out.

1. What happens if you invoke a value method and don't do anything with the result; that is, if you don't assign it to a variable or use it as part of a larger expression?
2. What happens if you use a void method as part of an expression? For example, try `System.out.println("boo!") + 7`;

Exercise 4.5 Draw a stack diagram that shows the state of the program the *second* time `zoop` is invoked. What is the complete output?

```
public static void zoop(String fred, int bob) {
    System.out.println(fred);
    if (bob == 5) {
        ping("not ");
    } else {
        System.out.println("!");
    }
}
```

```
public static void main(String[] args) {
    int bizz = 5;
    int buzz = 2;
    zoop("just for", bizz);
    clink(2 * buzz);
}
```

```
public static void clink(int fork) {
    System.out.print("It's ");
    zoop("breakfast ", fork);
}
```

```
public static void ping(String strangStrung) {
    System.out.println("any " + strangStrung + "more ");
}
```

Exercise 4.6 Many computations can be expressed more concisely using the “multadd” operation, which takes three operands and computes $a * b + c$. Some processors even provide a hardware implementation of this operation for floating-point numbers.

1. Create a new program called `Multadd.java`.
2. Write a method called `multadd` that takes three `doubles` as parameters and that returns $a * b + c$.
3. Write a `main` method that tests `multadd` by invoking it with a few simple parameters, like 1.0, 2.0, 3.0.
4. Also in `main`, use `multadd` to compute the following values:

$$\sin \frac{\pi}{4} + \frac{\cos \frac{\pi}{4}}{2}$$
$$\log 10 + \log 20$$

5. Write a method called `expSum` that takes a `double` as a parameter and that uses `multadd` to calculate:

$$xe^{-x} + \sqrt{1 - e^{-x}}$$

Hint: The method for raising e to a power is `Math.exp`.

In the last part of this exercise, you need to write a method that invokes another method you wrote. Whenever you do that, it is a good idea to test the first method carefully before working on the second. Otherwise, you might find yourself debugging two methods at the same time, which can be difficult.

One of the purposes of this exercise is to practice pattern-matching: the ability to recognize a specific problem as an instance of a general category of problems.

Chapter 5

Conditionals and Logic

The programs we've seen in previous chapters do pretty much the same thing every time, regardless of the input. For more complex computations, programs usually react to inputs, check for certain conditions, and generate applicable results. This chapter introduces Java language features for expressing logic and making decisions.

5.1 Relational Operators

Java has six **relational operators** that test the relationship between two values (e.g., whether they are equal, or whether one is greater than the other). The following expressions show how they are used:

```
x == y      // x is equal to y
x != y      // x is not equal to y
x > y       // x is greater than y
x < y       // x is less than y
x >= y      // x is greater than or equal to y
x <= y      // x is less than or equal to y
```

The result of a relational operator is one of two special values: **true** or **false**. These values belong to the data type **boolean**, named after the mathematician George Boole. He developed an algebraic way of representing logic.

You are probably familiar with these operators, but notice how Java is different from mathematical symbols like $=$, \neq , and \geq . A common error is to use a single `=` instead of a double `==` when comparing values. Remember that `=` is the *assignment* operator, and `==` is a *relational* operator. Also, the operators `=<` and `=>` do not exist.

The two sides of a relational operator have to be compatible. For example, the expression `5 < "6"` is invalid because `5` is an `int` and `"6"` is a `String`. When comparing values of different numeric types, Java applies the same conversion rules we saw previously with the assignment operator. For example, when evaluating the expression `5 < 6.0`, Java automatically converts the `5` to `5.0`.

5.2 The if-else Statement

To write useful programs, we almost always need to check conditions and react accordingly. **Conditional statements** give us this ability. The simplest conditional statement in Java is the `if` statement:

```
if (x > 0) {
    System.out.println("x is positive");
}
```

The expression in parentheses is called the condition. If it is true, the statements in braces get executed. If the condition is false, execution skips over that **block** of code. The condition in parentheses can be any `boolean` expression.

A second form of conditional statement has two possibilities, indicated by `if` and `else`. The possibilities are called **branches**, and the condition determines which branch gets executed:

```
if (x % 2 == 0) {
    System.out.println("x is even");
} else {
    System.out.println("x is odd");
}
```

If the remainder when `x` is divided by 2 is zero, we know that `x` is even, and the program displays a message to that effect. If the condition is false, the

second print statement is executed instead. Since the condition must be true or false, exactly one of the branches will run.

The braces are optional for branches that have only one statement. So we could have written the previous example this way:

```
if (x % 2 == 0)
    System.out.println("x is even");
else
    System.out.println("x is odd");
```

However, it's better to use braces – even when they are optional – to avoid making the mistake of adding statements to an `if` or `else` block and forgetting to add the braces. This code is misleading because it's not indented correctly:

```
if (x > 0)
    System.out.println("x is positive");
    System.out.println("x is not zero");
```

Since there are no braces, only the first `println` is part of the `if` statement. Here is what the compiler actually sees:

```
if (x > 0) {
    System.out.println("x is positive");
}
    System.out.println("x is not zero");
```

As a result, the second `println` runs no matter what. Even experienced programmers make this mistake; search the web for Apple's "goto fail" bug.

In all previous examples, notice how there is no semicolon at the end of the `if` or `else` lines. Instead, a new block should be defined using curly braces. Another common mistake is to put a semicolon after the condition, like this:

```
int x = 1;
if (x % 2 == 0); { // incorrect semicolon
    System.out.println("x is even");
}
```

This code will compile, but the program will output `"x is even"` regardless what value `x` is. Here is the same incorrect code with better formatting:

```
int x = 1;
if (x % 2 == 0)
    ; // empty statement
{
    System.out.println("x is even");
}
```

Because of the semicolon, the `if` statement compiles as if there are no braces, and the subsequent block runs independently. As a general rule, each line of Java code should end with a semicolon or brace – but not both.

The compiler won't complain if you omit optional braces or write empty statements. Doing so is allowed by the Java language, but it often results in bugs that are difficult to find. Development tools like Checkstyle (see Appendix A.5) can warn you about these and other kinds of programming mistakes.

5.3 Chaining and Nesting

Sometimes you want to check related conditions and choose one of several actions. One way to do this is by **chaining** a series of `if` and `else` blocks:

```
if (x > 0) {
    System.out.println("x is positive");
} else if (x < 0) {
    System.out.println("x is negative");
} else {
    System.out.println("x is zero");
}
```

These chains can be as long as you want, although they can be difficult to read if they get out of hand. One way to make them easier to read is to use standard indentation, as demonstrated in these examples. If you keep all the statements and braces lined up, you are less likely to make syntax errors.

Notice that the last branch is simply `else`, not `else if (x == 0)`. At this point in the chain, we know that `x` is not positive and `x` is not negative. There is no need to test whether `x` is zero, because there is no other possibility.

In addition to chaining, you can also make complex decisions by **nesting** one conditional statement inside another. We could have written the previous example as:

```
if (x > 0) {
    System.out.println("x is positive");
} else {
    if (x < 0) {
        System.out.println("x is negative");
    } else {
        System.out.println("x is zero");
    }
}
```

The outer conditional has two branches. The first branch contains a **print** statement, and the second branch contains another conditional statement, which has two branches of its own. These two branches are also **print** statements, but they could have been conditional statements as well.

These kinds of nested structures are common, but they can become difficult to read very quickly. Good indentation is essential to make the structure (or intended structure) apparent to the reader.

5.4 The switch Statement

If you need to make a series of decisions, chaining **else if** blocks can get long and redundant. For example, consider a program that converts integers like 1, 2, and 3 into words like **"one"**, **"two"**, and **"three"**:

```
if (number == 1) {
    word = "one";
} else if (number == 2) {
    word = "two";
} else if (number == 3) {
    word = "three";
} else {
    word = "unknown";
}
```

This chain could go on and on, especially for banking programs that write numbers in long form (e.g., “one hundred twenty-three and 45/100 dollars”). An alternative way to evaluate many possible values of an expression is to use a `switch` statement:

```
switch (number) {
    case 1:
        word = "one";
        break;
    case 2:
        word = "two";
        break;
    case 3:
        word = "three";
        break;
    default:
        word = "unknown";
        break;
}
```

The body of a `switch` statement is organized into one or more `case` blocks. Each `case` ends with a `break` statement, which exits the `switch` body. The `default` block is optional and executed only if none of the cases apply.

Although `switch` statements appear longer than chained `else if` blocks, they are particularly useful when multiple cases can be grouped:

```
switch (food) {
    case "apple":
    case "banana":
    case "cherry":
        System.out.println("Fruit!");
        break;
    case "asparagus":
    case "broccoli":
    case "carrot":
        System.out.println("Vegetable!");
        break;
}
```

5.5 Logical Operators

In addition to the relational operators, Java also has three **logical operators**: `&&`, `||`, and `!`, which respectively stand for *and*, *or*, and *not*. The results of these operators are similar to their meanings in English.

For example, `x > 0 && x < 10` is true when `x` is both greater than zero *and* less than 10.

The expression `x < 0 || x > 10` is true if either condition is true, that is, if `x` is less than 0 *or* greater than 10.

Finally, `!(x > 0)` is true if `x` is *not* greater than 0. The parentheses are necessary in this example because in the order of operations `!` comes before `>`.

In order for an expression with `&&` to be true, both sides of the `&&` operator must be true. And in order for an expression with `||` to be false, both sides of the `||` operator must be false.

The `&&` operator can be used to simplify nested `if` statements. For example, following code can be rewritten with a single condition.

```
if (x == 0) {
    if (y == 0) {
        System.out.println("Both x and y are zero");
    }
}
```

```
// combined
if (x == 0 && y == 0) {
    System.out.println("Both x and y are zero");
}
```

Likewise, the `||` operator can simplify chained `if` statements. Since the branches are the same, there is no need to duplicate that code.

```
if (x == 0) {
    System.out.println("Either x or y is zero");
} else if (y == 0) {
    System.out.println("Either x or y is zero");
}
```

```
// combined
if (x == 0 || y == 0) {
    System.out.println("Either x or y is zero");
}
```

Then again, if the statements in the branches were different, we could not combine them into one block. But it's useful to explore different ways of representing the same logic, especially when it's complex.

Logical operators evaluate the second expression only when necessary. For example, `true || anything` is always true, so Java does not need to evaluate the expression `anything`. Likewise, `false && anything` is always false.

Ignoring the second operand, when possible, is called **short circuit** evaluation, by analogy with an electrical circuit. Short circuit evaluation can save time, especially if `anything` takes a long time to evaluate. It can also avoid unnecessary errors, if `anything` might fail.

5.6 De Morgan's Laws

Sometimes you need to negate an expression containing a mix of relational and logical operators. For example, to test if `x` and `y` are both nonzero, you could write:

```
if (!(x == 0 || y == 0)) {
    System.out.println("Neither x nor y is zero");
}
```

This condition is difficult to read because of the `!` and parentheses. A better way to negate logic expressions is to apply **De Morgan's laws**:

- `!(A && B)` is the same as `!A || !B`
- `!(A || B)` is the same as `!A && !B`

In words, negating a logical expression is the same as negating each term and changing the operator. The `!` operator takes precedence over `&&` and `||`, so you don't have to put parentheses around the individual terms `!A` and `!B`.

De Morgan's laws also apply to the relational operators. In this case, negating each term means using the "opposite" relational operator.

- `!(x < 5 && y == 3)` is the same as `x >= 5 || y != 3`
- `!(x >= 1 || y != 7)` is the same as `x < 1 && y == 7`

It may help to read these examples out loud in English. For instance, “If I don’t want the case where x is less than 5 and y is 3, then I need x to be greater than or equal to 5, or I need y to be anything but 3.”

Returning to the previous example, here is the revised condition. In English, it reads “if x is not zero and y is not zero.” The logic is the same, and the source code is easier to read.

```
if (x != 0 && y != 0) {  
    System.out.println("Neither x nor y is zero");  
}
```

5.7 Boolean Variables

To store a `true` or `false` value, you need a `boolean` variable. You can declare and assign them like other variables. In this example, the first line is a variable declaration, the second is an assignment, and the third is both:

```
boolean flag;  
flag = true;  
boolean testResult = false;
```

Since relational and logical operators evaluate to a `boolean` value, you can store the result of a comparison in a variable:

```
boolean evenFlag = (n % 2 == 0);    // true if n is even  
boolean positiveFlag = (x > 0);    // true if x is positive
```

The parentheses are unnecessary, but they make the code easier to understand. A variable defined in this way is called a **flag**, because it signals or “flags” the presence or absence of a condition.

You can use flag variables as part of a conditional statement:

```
if (evenFlag) {  
    System.out.println("n was even when I checked it");  
}
```

Flags may not seem that useful at this point, but they will help simplify complex conditions later on. Each part of a condition can be stored in a separate flag, and these flags can be combined with logical operators.

Notice that we didn't have to write `if (evenFlag == true)`. Since `evenFlag` is a `boolean`, it's already a condition. To check if a flag is `false`, we simply negate the flag:

```
if (!evenFlag) {
    System.out.println("n was odd when I checked it");
}
```

In general, you should never compare anything to true or false. Doing so makes the code more verbose and awkward to read out loud.

5.8 Boolean Methods

Methods can return `boolean` values, just like any other type, which is often convenient for hiding tests inside methods. For example:

```
public static boolean isSingleDigit(int x) {
    if (x > -10 && x < 10) {
        return true;
    } else {
        return false;
    }
}
```

The name of this method is `isSingleDigit`. It is common to give `boolean` methods names that sound like yes/no questions. Since the return type is `boolean`, the return statement has to provide a boolean expression.

The code itself is straightforward, although it is longer than it needs to be. Remember that the expression `x > -10 && x < 10` has type `boolean`, so there is nothing wrong with returning it directly (without the `if` statement):

```
public static boolean isSingleDigit(int x) {
    return x > -10 && x < 10;
}
```

In `main`, you can invoke the method in the usual ways:

```
System.out.println(isSingleDigit(2));
boolean bigFlag = !isSingleDigit(17);
```

The first line displays `true` because 2 is a single-digit number. The second line sets `bigFlag` to `true`, because 17 is *not* a single-digit number.

Conditional statements often invoke `boolean` methods and use the result as the condition:

```
if (isSingleDigit(z)) {
    System.out.println("z is small");
} else {
    System.out.println("z is big");
}
```

Examples like this one almost read like English: “If is single digit z, print z is small else print z is big.”

5.9 Validating Input

One of the most important tasks in any computer program is to **validate** input from the user. People often make mistakes while typing, especially on smartphones, and incorrect inputs may cause your program to fail.

Even worse, someone (i.e., a **hacker**) may intentionally try to break into your system by entering unexpected inputs. You should never assume that users will input the right kind of data.

Consider this simple program that prompts the user for a number and computes its logarithm:

```
Scanner in = new Scanner(System.in);
System.out.print("Enter a number: ");
double x = in.nextDouble();
double y = Math.log(x);
System.out.println("The log is " + y);
```

In mathematics, the natural logarithm (base e) is undefined when $x \leq 0$. In Java, if you ask for `Math.log(-1)`, it returns `NaN`, which stands for “not a number”. We can check for this condition and print an appropriate message:

```
if (x > 0) {
    double y = Math.log(x);
    System.out.println("The log is " + y);
} else {
    System.out.println("The log is undefined");
}
```

The output is better now, but there is another problem. What if the user doesn’t enter a number at all? What would happen if they typed the word “hello”, either on accident or on purpose?

```
Exception in thread "main" java.util.InputMismatchException
    at java.util.Scanner.throwFor(Scanner.java:864)
    at java.util.Scanner.next(Scanner.java:1485)
    at java.util.Scanner.nextDouble(Scanner.java:2413)
    at Logarithm.main(Logarithm.java:8)
```

If the user inputs a `String` when we expect a `double`, Java reports an “input mismatch” exception. We can prevent this run-time error from happening by testing the input first.

The `Scanner` class provides `hasNextDouble`, which checks whether the next input can be interpreted as a `double`. If not, we can display an error message.

```
if (!in.hasNextDouble()) {
    String word = in.next();
    System.err.println(word + "is not a number");
}
```

In contrast to `in.nextLine`, which returns an entire line of input, the `in.next` method returns only the next token of input. We can use `in.next` to show the user exactly which word they typed was not a number.

This example also uses `System.err`, which is an `OutputStream` for error messages and warnings. Some development environments display output to `System.err` with a different color or in a separate window.

5.10 Example Program

In this chapter we have seen relational and logical operators, `if` statements, boolean methods, and validating input. The following program shows how the individual code examples in the previous section fit together.

```
import java.util.Scanner;

/**
 * Demonstrates input validation using if statements.
 */
public class Logarithm {

    public static void main(String[] args) {

        // prompt for input
        Scanner in = new Scanner(System.in);
        System.out.print("Enter a number: ");

        // check the format
        if (!in.hasNextDouble()) {
            String word = in.next();
            System.err.println(word + " is not a number");
            return;
        }

        // check the range
        double x = in.nextDouble();
        if (x > 0) {
            double y = Math.log(x);
            System.out.println("The log is " + y);
        } else {
            System.out.println("The log is undefined");
        }
    }
}
```

Notice how the `return` statement allows you to exit a method before you reach the end of it. Returning from `main` terminates the program.

What started as five lines of code at the beginning of Section 5.9 is now a 30-line program. Making programs robust (and secure) often requires a lot of additional checking, as shown in this example.

It's important to write comments every few lines to make your code easier to understand. Comments not only help other people read your code, they also help you document what you're trying to do. If there's a mistake the code, it's a lot easier to find when there are good comments.

5.11 Vocabulary

boolean: A data type with only two possible values, `true` and `false`.

relational operator: An operator that compares two values and produces a `boolean` indicating the relationship between them.

conditional statement: A statement that uses a condition to determine which statements to execute.

block: A sequence of statements, surrounded by braces, that generally runs as the result of a condition.

branch: One of the alternative blocks after a conditional statement. For example, an `if-else` statement has two branches.

chaining: A way of joining several conditional statements in sequence.

nesting: Putting a conditional statement inside one or both branches of another conditional statement.

logical operator: An operator that combines boolean values and produces a boolean value.

short circuit: A way of evaluating logical operators that only evaluates the second operand if necessary.

De Morgan's laws: Mathematical rules that show how to negate a logical expression.

flag: A variable (usually `boolean`) that represents a condition or status.

validate: To confirm that an input value is of the correct type and within the expected range.

hacker: A programmer who breaks into computer systems. The term hacker may also apply to someone who enjoys writing code.

NaN: A special floating-point value that stands for “not a number”.

5.12 Exercises

The code for this chapter is in the `ch05` directory of `ThinkJavaCode2`. See page xix for instructions on how to download the repository. Before you start the exercises, we recommend that you compile and run the examples.

If you have not already read Appendix A.5, now might be a good time. It describes Checkstyle, a tool that analyzes many aspects of your source code.

Exercise 5.1 Rewrite the following code using a single `if` statement.

```
if (x > 0) {
    if (x < 10) {
        System.out.println("positive single digit number.");
    }
}
```

Exercise 5.2 Now that we have conditional statements, we can get back to the “Guess My Number” game from Exercise 3.4.

You should already have a program that chooses a random number, prompts the user to guess it, and displays the difference between the guess and the chosen number.

Adding a small amount of code at a time, and testing as you go, modify the program so it tells the user whether the guess is too high or too low, and then prompts the user for another guess.

The program should continue until the user gets it right or guesses incorrectly three times. If the user guesses the correct number, display a message and terminate the program.

Exercise 5.3 Fermat’s Last Theorem says that there are no integers a , b , c , and n such that $a^n + b^n = c^n$, except when $n \leq 2$.

Write a program named `Fermat.java` that inputs four integers (a , b , c , and n) and checks to see if Fermat’s theorem holds. If n is greater than 2 and $a^n + b^n = c^n$, the program should display “Holy smokes, Fermat was wrong!” Otherwise the program should display “No, that doesn’t work.”

Hint: You might want to use `Math.pow`.

Exercise 5.4 Using the following variables, evaluate the logic expressions in the table below. Write your answers as true, false, or error.

```
boolean yes = true;
boolean no = false;
int loVal = -999;
int hiVal = 999;
double grade = 87.5;
double amount = 50.0;
String hello = "world";
```

Expression	Result
<code>yes == no grade > amount</code>	
<code>amount == 40.0 50.0</code>	
<code>hiVal != loVal loVal < 0</code>	
<code>True hello.length() > 0</code>	
<code>hello.isEmpty() && yes</code>	
<code>grade <= 100 && !false</code>	
<code>!yes no</code>	
<code>grade > 75 > amount</code>	
<code>amount <= hiVal && amount >= loVal</code>	
<code>no && !no yes && !yes</code>	

Exercise 5.5 What is the output of the following program? Determine the answer without using a computer.

```
public static void main(String[] args) {
    boolean flag1 = isHoopy(202);
    boolean flag2 = isFrabjuous(202);
    System.out.println(flag1);
    System.out.println(flag2);
    if (flag1 && flag2) {
        System.out.println("ping!");
    }
    if (flag1 || flag2) {
        System.out.println("pong!");
    }
}
```

```
public static boolean isHoopy(int x) {
    boolean hoopyFlag;
    if (x % 2 == 0) {
        hoopyFlag = true;
    } else {
        hoopyFlag = false;
    }
    return hoopyFlag;
}
```

```
public static boolean isFrabjuous(int x) {
    boolean frabjuousFlag;
    if (x > 0) {
        frabjuousFlag = true;
    } else {
        frabjuousFlag = false;
    }
    return frabjuousFlag;
}
```

The purpose of this exercise is to make sure you understand logical operators and the flow of execution through methods.

Exercise 5.6 Write a program named `Quadratic.java` that finds the roots of $ax^2 + bx + c = 0$ using the quadratic formula:

$$x = \frac{-b \pm \sqrt{b^2 - 4ac}}{2a}$$

Prompt the user to input integers for a , b , and c . Compute the two solutions for x , and display the results.

Your program should be able to handle inputs for which there is only one or no solution. Specifically, it should not divide by zero or take the square root of a negative number.

Be sure to validate all inputs. The user should never see an input mismatch exception. Display specific error messages that include the invalid input.

Exercise 5.7 If you are given three sticks, you may or may not be able to arrange them in a triangle. For example, if one of the sticks is 12 inches long and the other two are one inch long, you will not be able to get the short sticks to meet in the middle. For any three lengths, there is a simple test to see if it is possible to form a triangle:

If any of the three lengths is greater than the sum of the other two,
you cannot form a triangle.

Write a program named `Triangle.java` that inputs three integers, and then outputs whether you can (or cannot) form a triangle from the given lengths. Reuse your code from the previous exercise to validate the inputs. Display an error if any of the lengths are negative or zero.

Chapter 6

Loops and Strings

Computers are often used to automate repetitive tasks, such as searching for text in documents. Repeating tasks without making errors is something that computers do well and people do poorly.

In this chapter, we'll learn how to use `while` and `for` loops to add repetition to your code. We'll also take a first look at `String` methods and solve some interesting problems.

6.1 The while Statement

Using a `while` statement, we can repeat the same code multiple times:

```
int n = 3;
while (n > 0) {
    System.out.println(n);
    n = n - 1;
}
System.out.println("Blastoff!");
```

Reading the code in English sounds like: “Start with `n` set to 3. While `n` is greater than zero, print the value of `n`, and reduce the value of `n` by 1. When you get to zero, print Blastoff!” So the output is:

```
3
2
1
Blastoff!
```

The flow of execution for a `while` statement is:

1. Evaluate the condition in parentheses, yielding `true` or `false`.
2. If the condition is `false`, skip the following statements in braces.
3. If the condition is `true`, execute the statements and go back to step 1.

This type of flow is called a **loop**, because the last step “loops back around” to the first. Figure 6.1 shows this idea using a flowchart.

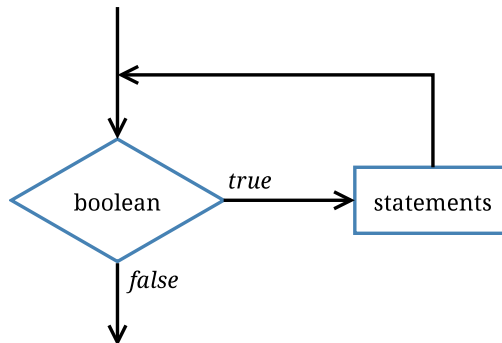

Figure 6.1: Flow of execution for a `while` loop.

The **body** of the loop should change the value of one or more variables so that, eventually, the condition becomes `false` and the loop terminates. Otherwise the loop will repeat forever, which is called an **infinite loop**.

```
int n = 3;
while (n > 0) {
    System.out.println(n);
    // n never changes
}
```

This example will print the number 3 forever, or at least until you terminate the program. An endless source of amusement for computer scientists is the

observation that the directions on shampoo, “Lather, rinse, repeat,” are an infinite loop.

In the first example, we can prove that the loop terminates when n is positive. But in general, it is not so easy to tell whether a loop terminates. For example, this loop continues until n is 1 (which makes the condition `false`):

```
while (n != 1) {
    System.out.println(n);
    if (n % 2 == 0) {           // n is even
        n = n / 2;
    } else {                   // n is odd
        n = 3 * n + 1;
    }
}
```

Each time through the loop, the program displays the value of n and then checks whether it is even or odd. If it is even, the value of n is divided by two. If it is odd, the value is replaced by $3n + 1$. For example, if the starting value is 3, the resulting sequence is 3, 10, 5, 16, 8, 4, 2, 1.

Since n sometimes increases and sometimes decreases, there is no obvious proof that n will ever reach 1 and that the program will ever terminate. For some values of n , such as the powers of two, we can prove that it terminates. The previous example ends with such a sequence, starting when n is 16 (or 2^4).

The hard question is whether this program terminates for *all* values of n . So far, no one has been able to prove it *or* disprove it! For more information, see https://en.wikipedia.org/wiki/Collatz_conjecture.

6.2 Increment and Decrement

Here is another `while` loop example; this one displays the numbers 1 to 5.

```
int i = 1;
while (i <= 5) {
    System.out.println(i);
    i++; // add 1 to i
}
```

Assignments like `i = i + 1` don't often appear in loops, because Java provides a more concise way to add and subtract by one. Specifically, `++` is the **increment** operator; it has the same effect as `i = i + 1`. And `--` is the **decrement** operator; it has the same effect as `i = i - 1`.

If you want to increment or decrement a variable by an amount other than 1, you can use `+=` and `-=`. For example, `i += 2` increments `i` by 2.

```
int i = 2;
while (i <= 8) {
    System.out.print(i + ", ");
    i += 2; // add 2 to i
}
System.out.println("Who do we appreciate?");
```

And the output is:

```
2, 4, 6, 8, Who do we appreciate?
```

6.3 The for Statement

The loops we have written so far have three parts in common. They start by initializing a variable, they have a condition that depends on that variable, and they do something inside the loop to update that variable.

Running the same code multiple times is called **iteration**. It's so common that there is another statement, the `for` loop, that expresses it more concisely. For example, we can rewrite the 2-4-6-8 loop this way:

```
for (int i = 2; i <= 8; i += 2) {
    System.out.print(i + ", ");
}
System.out.println("Who do we appreciate?");
```

`for` loops have three components in parentheses, separated by semicolons: the initializer, the condition, and the update.

1. The *initializer* runs once at the very beginning of the loop. It is equivalent to the line before the `while` statement.

2. The *condition* is checked each time through the loop. If it is `false`, the loop ends. Otherwise, the body of the loop is executed (again).
3. At the end of each iteration, the *update* runs, and we go back to step 2.

The `for` loop is often easier to read because it puts all the loop-related statements at the top of the loop. Doing so allows you to focus on the statements inside the loop body. Figure 6.2 illustrates `for` loops with a flowchart.

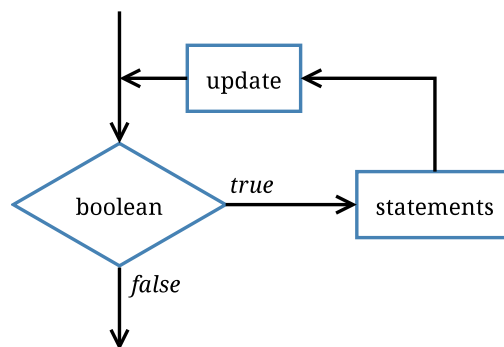

Figure 6.2: Flow of execution for a `for` loop.

There is another difference between `for` loops and `while` loops: if you declare a variable in the initializer, it only exists *inside* the `for` loop. For example:

```
for (int n = 3; n > 0; n--) {
    System.out.println(n);
}
System.out.println("n is now " + n); // compiler error
```

The last line tries to display `n` (for no reason other than demonstration), but it won't work. If you need to use a loop variable outside the loop, you have to declare it *outside* the loop, like this:

```
int n;
for (n = 3; n > 0; n--) {
    System.out.println(n);
}
System.out.println("n is now " + n);
```

Notice that the `for` statement does not say `int n = 3`. Rather, it simply initializes the existing variable `n`.

6.4 Nested Loops

Like conditional statements, loops can be nested one inside the other. Nested loops allow you to iterate over two variables. For example, we can generate a “multiplication table” like this:

```
for (int x = 1; x <= 10; x++) {  
    for (int y = 1; y <= 10; y++) {  
        System.out.printf("%4d", x * y);  
    }  
    System.out.println();  
}
```

Variables like `x` and `y` are called **loop variables**, because they control the execution of a loop. In this example, the first loop (`for x`) is known as the “outer loop”, and the second loop (`for y`) is known as the “inner loop”.

Each loop repeats their corresponding statements 10 times. The outer loop iterates from 1 to 10 only once, but the inner loop iterates from 1 to 10 each of those 10 times. As a result, the `printf` method is invoked 100 times.

The format specifier `%4d` displays the value of `x * y` padded with spaces so it’s four characters wide. Doing so causes the output to align vertically, regardless of how many digits the numbers have:

```
1  2  3  4  5  6  7  8  9 10  
2  4  6  8 10 12 14 16 18 20  
3  6  9 12 15 18 21 24 27 30  
4  8 12 16 20 24 28 32 36 40  
5 10 15 20 25 30 35 40 45 50  
6 12 18 24 30 36 42 48 54 60  
7 14 21 28 35 42 49 56 63 70  
8 16 24 32 40 48 56 64 72 80  
9 18 27 36 45 54 63 72 81 90  
10 20 30 40 50 60 70 80 90 100
```

It’s important to realize that the output is displayed row by row. The inner loop displays a single row of output, followed by a newline. The outer loop iterates over the rows themselves. Another way to read nested loops, like the ones in this example, is “for each row `x`, and for each column `y`, ...”

6.5 Characters

Some of the most interesting problems in computer science involve searching and manipulating text. In the next few sections, we'll discuss how to apply loops to strings. Although the examples are short, the techniques work the same whether you have one word or one million words.

Strings provide a method named `charAt`. It returns a `char`, a data type that stores an individual character (as opposed to strings of them).

```
String fruit = "banana";  
char letter = fruit.charAt(0);
```

The argument `0` means that we want the character at **index** `0`. String indexes range from `0` to $n - 1$, where n is the length of the string. So the character assigned to `letter` is `b`.

b	a	n	a	n	a
0	1	2	3	4	5

Characters work like the other data types we have seen. You can compare them using relational operators:

```
if (letter == 'A') {  
    System.out.println("It's an A!");  
}
```

Character literals, like `'A'`, appear in single quotes. Unlike string literals, which appear in double quotes, character literals can only contain a single character. Escape sequences, like `'\t'`, are legal because they represent a single character.

The increment and decrement operators also work with characters. So this loop displays the letters of the alphabet:

```
System.out.print("Roman alphabet: ");  
for (char c = 'A'; c <= 'Z'; c++) {  
    System.out.print(c);  
}  
System.out.println();
```

The output is:

```
ABCDEFGHIJKLMNOPQRSTUVWXYZ
```

Java uses **Unicode** to represent characters, so strings can store text in other alphabets like Cyrillic and Greek, and non-alphabetic languages like Chinese. You can read more about it at <https://unicode.org/>.

In Unicode, each character is represented by a “code point”, which you can think of as an integer. The code points for uppercase Greek letters run from 913 to 937, so we can display the Greek alphabet like this:

```
System.out.print("Greek alphabet: ");
for (int i = 913; i <= 937; i++) {
    System.out.print((char) i);
}
System.out.println();
```

This example uses a type cast to convert each integer (in the range) to the corresponding character. Try running the code and see what happens.

6.6 Which Loop to Use

`for` and `while` loops have the same capabilities; any `for` loop can be rewritten as a `while` loop, and vice versa. For example, we could have printed letters of the alphabet using a `while` loop:

```
System.out.print("Roman alphabet: ");
char c = 'A';
while (c <= 'Z') {
    System.out.print(c);
    c++;
}
System.out.println();
```

You might wonder when to use one or the other. It depends on whether you know how many times the loop will repeat.

A `for` loop is “definite”, which means we know, at the beginning of the loop, how many times it will repeat. In the alphabet example, we know it will run

26 times. In that case, it's better to use a `for` loop, which puts all of the loop control code on one line.

A `while` loop is “indefinite”, which means we don't know how many times it will repeat. For example, when validating user input as in Section 5.9, it's impossible to know how many times the user will enter a wrong value. In this case, a `while` loop is more appropriate.

```
System.out.print("Enter a number: ");
while (!in.hasNextDouble()) {
    String word = in.next();
    System.err.println(word + " is not a number");
    System.out.print("Enter a number: ");
}
double number = in.nextDouble();
```

It's easier to read the `Scanner` method calls when they're not all on one line of code.

6.7 String Iteration

Strings provide a method called `length` that returns the number of characters in the string. The following loop iterates the characters in `fruit` and displays them, one on each line:

```
for (int i = 0; i < fruit.length(); i++) {
    char letter = fruit.charAt(i);
    System.out.println(letter);
}
```

Because `length` is a method, you have to invoke it with parentheses (there are no arguments). When `i` is equal to the length of the string, the condition becomes `false` and the loop terminates.

To find the last letter of a string, you might be tempted to do something like:

```
int length = fruit.length();
char last = fruit.charAt(length);    // wrong!
```

This code compiles and runs, but invoking the `charAt` method throws a `StringIndexOutOfBoundsException`. The problem is that there is no sixth letter in `"banana"`. Since we started counting at 0, the 6 letters are indexed from 0 to 5. To get the last character, you have to subtract 1 from `length`.

```
int length = fruit.length();
char last = fruit.charAt(length - 1); // correct
```

Many string algorithms involve reading one string and building another. For example, to reverse a string, we can concatenate one character at a time:

```
public static String reverse(String s) {
    String r = "";
    for (int i = s.length() - 1; i >= 0; i--) {
        r += s.charAt(i);
    }
    return r;
}
```

The initial value of `r` is `""`, which is the **empty string**. The loop iterates the letters of `s` in reverse order. Each time through the loop, it creates a new string and assigns it to `r`. When the loop exits, `r` contains the letters from `s` in reverse order. So the result of `reverse("banana")` is `"ananab"`.

6.8 The `indexOf` Method

To search for a specific character in a string, you could write a `for` loop and use `charAt` like in the previous section. However, the `String` class already provides a method for doing just that.

```
String fruit = "banana";
int index = fruit.indexOf('a'); // returns 1
```

This example finds the index of `'a'` in the string. But the letter appears three times, so it's not obvious what `indexOf` might do. According to the documentation, it returns the index of the *first* appearance.

To find subsequent appearances, you can use another version of `indexOf`, which takes a second argument that indicates where in the string to start looking.

```
int index = fruit.indexOf('a', 2); // returns 3
```

To visualize how `indexOf` and other `String` methods work, it helps to draw a picture like Figure 6.3. The previous code starts at index 2 (the first `'n'`) and finds the next `'a'`, which is at index 3.



Figure 6.3: Memory diagram for a `String` of six characters.

If the character happens to appear at the starting index, the starting index is the answer. So `fruit.indexOf('a', 5)` returns 5. If the character does not appear in the string, `indexOf` returns `-1`. Since indexes cannot be negative, this value indicates the character was not found.

You can also use `indexOf` to search for an entire string, not just a single character. For example, the expression `fruit.indexOf("nan")` returns 2.

6.9 Substrings

In addition to searching strings, we often need to extract parts of strings. The `substring` method returns a new string that copies letters from an existing string, given a pair of indexes.

- `fruit.substring(0, 3)` returns `"ban"`
- `fruit.substring(2, 5)` returns `"nan"`
- `fruit.substring(6, 6)` returns `""`

Notice that the character indicated by the second index is *not* included. Defining `substring` this way simplifies some common operations. For example, to select a substring with length `len`, starting at index `i`, you could write `fruit.substring(i, i + len)`.

Like most string methods, `substring` is **overloaded**. That is, there are other versions of `substring` that have different parameters. If it's invoked with one argument, it returns the letters from that index to the end.

- `fruit.substring(0)` returns `"banana"`
- `fruit.substring(2)` returns `"nana"`
- `fruit.substring(6)` returns `""`

The first example returns a copy of the entire string. The second example returns all but the first two characters. As the last example shows, `substring` returns the empty string if the argument is the length of the string.

We could also use `fruit.substring(2, fruit.length() - 1)` to get the result `"nana"`. But calling `substring` with one argument is more convenient when you want the end of the string.

6.10 String Comparison

When comparing strings, it might be tempting to use the `==` and `!=` operators. But that will almost never work. The following code compiles and runs, but it always prints `"Goodbye!"` regardless what the user types.

```
System.out.print("Play again? ");
String answer = in.nextLine();
if (answer == "yes") {                               // wrong!
    System.out.println("Let's go!");
} else {
    System.out.println("Goodbye!");
}
```

The problem is that the `==` operator checks whether the two operands refer to the *same object*. Even if `answer` is `"yes"`, it will refer to a different object in memory than the literal string `"yes"` in the code. We'll learn more about objects and references in the next chapter.

The correct way to compare strings is with the `equals` method, like this:

```
if (answer.equals("yes")) {
    System.out.println("Let's go!");
}
```

This example invokes `equals` on `answer` and passes `"yes"` as an argument. The `equals` method returns `true` if the strings contain the same characters; otherwise it returns `false`.

If two strings differ, we can use `compareTo` to see which comes first in alphabetical order:

```
String name1 = "Alan Turing";
String name2 = "Ada Lovelace";
int diff = name1.compareTo(name2);
if (diff < 0) {
    System.out.println("name1 comes before name2.");
} else if (diff > 0) {
    System.out.println("name2 comes before name1.");
} else {
    System.out.println("The names are the same.");
}
```

The return value from `compareTo` is the difference between the first characters in the strings that are not the same. In the preceding code, `compareTo` returns positive 8, because the second letter of `"Ada"` comes before the second letter of `"Alan"` by 8 letters.

If the first string (the one on which the method is invoked) comes earlier in the alphabet, the difference is negative. If it comes later in the alphabet, the difference is positive. If the strings are equal, their difference is zero.

Both `equals` and `compareTo` are case-sensitive. In Unicode, uppercase letters come before lowercase letters. So `"Ada"` comes before `"ada"`.

6.11 String Formatting

In Section 3.5, we learned how to use `System.out.printf` to display formatted output. Sometimes programs need to create strings that are formatted a certain way, but not display them immediately (or ever). For example, the following method returns a time string in 12-hour format:

```
public static String timeString(int hour, int minute) {
    String ampm;
    if (hour < 12) {
        ampm = "AM";
        if (hour == 0) {
            hour = 12; // midnight
        }
    } else {
        ampm = "PM";
        hour = hour - 12;
    }
    return String.format("%02d:%02d %s", hour, minute, ampm);
}
```

`String.format` takes the same arguments as `System.out.printf`: a format specifier followed by a sequence of values. The main difference is that `System.out.printf` displays the result on the screen. `String.format` creates a new string, but does not display anything.

In this example, the format specifier `%02d` means “two digit integer padded with zeros”, so `timeString(19, 5)` returns the string `"07:05 PM"`. As an exercise, try writing two nested `for` loops (in `main`) that invoke `timeString` and display all possible times over a 24-hour period.

Be sure to skim through the documentation for `String`. Knowing what other methods are there will help you avoid reinventing the wheel. The easiest way to find documentation for Java classes is to do a web search for “Java” and the name of the class.

6.12 Vocabulary

loop: A statement that executes a sequence of statements repeatedly.

loop body: The statements inside the loop.

infinite loop: A loop whose condition is always true.

increment: Increase the value of a variable.

decrement: Decrease the value of a variable.

iteration: Executing a sequence of statements repeatedly.

loop variable: A variable that is initialized, tested, and updated in order to control a loop.

index: An integer variable or value used to indicate a character in a string.

Unicode: An international standard for representing characters in most of the world's languages.

empty string: The string `""`, which contains no characters and has a length of zero.

overloading: Defining two or more methods with the same name but different parameters.

6.13 Exercises

The code for this chapter is in the `ch06` directory of `ThinkJavaCode2`. See page xix for instructions on how to download the repository. Before you start the exercises, we recommend that you compile and run the examples.

If you have not already read Appendix A.6, now might be a good time. It describes the DrJava debugger, which is a useful tool for visualizing the flow of execution through loops.

Exercise 6.1 Consider the following methods (`main` and `loop`).

1. Draw a table that shows the value of the variables `i` and `n` during the execution of `loop`. The table should contain one column for each variable and one line for each iteration.
2. What is the output of this program?
3. Can you prove that this loop terminates for any positive value of `n`?

```

public static void main(String[] args) {
    loop(10);
}

public static void loop(int n) {
    int i = n;
    while (i > 1) {
        System.out.println(i);
        if (i % 2 == 0) {
            i = i / 2;
        } else {
            i = i + 1;
        }
    }
}

```

Exercise 6.2 Let's say you are given a number, a , and you want to find its square root. One way to do that is to start with a rough guess about the answer, x_0 , and then improve the guess using this formula:

$$x_1 = (x_0 + a/x_0)/2$$

For example, if we want to find the square root of 9, and we start with $x_0 = 6$, then $x_1 = (6 + 9/6)/2 = 3.75$, which is closer. We can repeat the procedure, using x_1 to calculate x_2 , and so on. In this case, $x_2 = 3.075$ and $x_3 = 3.00091$. So it converges quickly on the correct answer.

Write a method called `squareRoot` that takes a `double` and returns an approximation of the square root of the parameter, using this technique. You should not use `Math.sqrt`.

As your initial guess, you should use $a/2$. Your method should iterate until it gets two consecutive estimates that differ by less than 0.0001. You can use `Math.abs` to calculate the absolute value of the difference.

Exercise 6.3 One way to evaluate $\exp(-x^2)$ is to use the infinite series expansion:

$$\exp(-x^2) = 1 - x^2 + x^4/2 - x^6/6 + \dots$$

The i th term in this series is $(-1)^i x^{2i}/i!$. Write a method named `gauss` that

takes `x` and `n` as arguments and returns the sum of the first `n` terms of the series. You should not use `factorial` or `pow`.

Exercise 6.4 A word is said to be “abecedarian” if the letters in the word appear in alphabetical order. For example, the following are all six-letter English abecedarian words:

abdest, acknow, acorsy, adempt, adipsy, agnosy, befist, behint, beknow, bijoux, biopsy, cestuy, chintz, deflux, dehors, dehort, deinos, diluvy, dimpsy

Write a method called `isAbecedarian` that takes a `String` and returns a `boolean` indicating whether the word is abecedarian.

Exercise 6.5 A word is said to be a “doubloon” if every letter that appears in the word appears exactly twice. Here are some example doubloons found in the dictionary:

Abba, Anna, appall, appearer, appeases, arrainging, beriberi, bilabial, boob, Caucasus, coco, Dada, deed, Emmett, Hannah, horse-shoer, intestines, Isis, mama, Mimi, murmur, noon, Otto, papa, peep, reappear, redder, sees, Shanghaiings, Toto

Write a method called `isDoubloon` that takes a string and checks whether it is a doubloon. To ignore case, invoke the `toLowerCase` method before checking.

Exercise 6.6 In Scrabble¹ each player has a set of tiles with letters on them. The object of the game is to use those letters to spell words. The scoring system is complex, but longer words are usually worth more than shorter words.

Imagine you are given your set of tiles as a string, like `"quijibo"`, and you are given another string to test, like `"jib"`.

Write a method called `canSpell` that takes two strings and checks whether the set of tiles can spell the word. You might have more than one tile with the same letter, but you can only use each tile once.

¹Scrabble is a registered trademark owned in the USA and Canada by Hasbro Inc., and in the rest of the world by J. W. Spear & Sons Limited of Maidenhead, Berkshire, England, a subsidiary of Mattel Inc.

Chapter 7

Arrays and References

Up to this point, the only variables we have used were for individual values such as numbers or strings. In this chapter, we'll learn how to store multiple values of the same type using a single variable. This language feature will enable you to write programs that manipulate larger amounts of data.

For example, Exercise 6.5 asked you to check whether every letter in a string appears exactly twice. One algorithm (which hopefully you already discovered) is to loop through the string 26 times, once for each lowercase letter:

```
// outer loop: for each lowercase letter
for (char c = 'a'; c <= 'z'; c++) {
    // inner loop: count how many times the letter appears
    for (int i = 0; i < str.length(); i++) {
        ...
        // if the count is not 0 or 2, return false
    }
}
```

This “nested loops” approach is inefficient, especially when the string is long. For example, there are more than 3 million characters in *War and Peace*; to process the whole book, the nested loop would run about 80 million times.

Another algorithm would initialize 26 variables to zero, loop through the string *one time*, and use a giant **if** statement to update the variable for each letter. But who wants to declare 26 variables?

That's where arrays come in. We can use a single variable to store 26 integers. Rather than use an **if** statement to update each value, we can use arithmetic

to update the *n*th value directly. We will present this algorithm at the end of the chapter.

7.1 Creating Arrays

An **array** is a sequence of values; the values in the array are called **elements**. You can make an array of **ints**, **doubles**, **Strings**, or any other type, but all the values in an array must have the same type.

To create an array, you have to declare a variable with an *array type* and then create the array itself. Array types look like other Java types, except they are followed by square brackets (`[]`). For example, the following lines declare that **counts** is an “integer array” and **values** is a “double array”:

```
int[] counts;  
double[] values;
```

To create the array itself, you have to use the **new** operator, which we first saw in Section 3.2. The **new** operator **allocates** memory for the array and automatically initializes all of its elements to zero.

```
counts = new int[4];  
values = new double[size];
```

The first assignment makes **counts** refer to an array of four integers. The second makes **values** refer to an array of **doubles**, but the number of elements depends on the value of **size** (at the time the array is created).

Of course, you can also declare the variable and create the array with a single line of code:

```
int[] counts = new int[4];  
double[] values = new double[size];
```

You can use any integer expression for the size of an array, as long as the value is nonnegative. If you try to create an array with `-4` elements, for example, you will get a `NegativeArraySizeException`. An array with zero elements is allowed, and there are special uses for such arrays that we’ll see later on.

You can initialize an array with an **array literal**, which is a comma-separated sequence of elements enclosed in braces, like this:

```
int[] a = {1, 2, 3, 4};
```

This statement creates an array variable, `a`, and makes it refer to an array with four elements.

7.2 Accessing Elements

When you create an array with the `new` operator, the elements are initialized to zero. Figure 7.1 shows a memory diagram of the `counts` array so far.

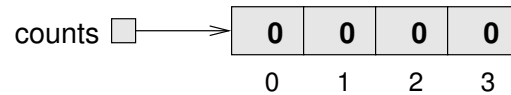

Figure 7.1: Memory diagram of an `int` array.

The arrow indicates that the value of `counts` is a **reference** to the array. You should think of *the array* and *the variable* that refers to it as two different things. As we'll soon see, we can assign a different variable to refer to the same array, and we can change the value of `counts` to refer to a different array.

The boldface numbers inside the boxes are the elements of the array. The lighter numbers outside the boxes are the **indexes** used to identify each location in the array. As with strings, the index of the first element is 0, not 1. For this reason, we sometimes refer to the first element as the “zeroth” element.

The `[]` operator selects elements from an array:

```
System.out.println("The zeroth element is " + counts[0]);
```

You can use the `[]` operator anywhere in an expression:

```
counts[0] = 7;
counts[1] = counts[0] * 2;
counts[2]++;
counts[3] -= 60;
```

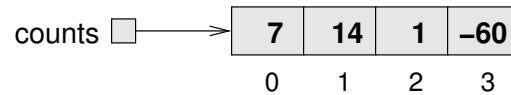

Figure 7.2: Memory diagram after several assignment statements.

Figure 7.2 shows the result of these statements.

You can use any expression as an index, as long as it has type `int`. One of the most common ways to index an array is with a loop variable. For example:

```
int i = 0;
while (i < 4) {
    System.out.println(counts[i]);
    i++;
}
```

This `while` loop counts up from 0 to 4. When `i` is 4, the condition fails and the loop terminates. So the body of the loop is only executed when `i` is 0, 1, 2, and 3. In this context, the variable name `i` is short for “index”.

Each time through the loop we use `i` as an index into the array, displaying the `i`th element. This type of array processing is usually written as a `for` loop.

```
for (int i = 0; i < 4; i++) {
    System.out.println(counts[i]);
}
```

For the `counts` array, the only legal indexes are 0, 1, 2, and 3. If the index is negative or greater than 3, the result is an `ArrayIndexOutOfBoundsException`.

7.3 Displaying Arrays

You can use `println` to display an array, but it probably doesn’t do what you would like. For example, if you print an array like this:

```
int[] a = {1, 2, 3, 4};
System.out.println(a);
```

The output is something like:

```
[I@bf3f7e0
```

The bracket indicates that the value is an array, I stands for “integer”, and the rest represents the address of the array in memory.

If we want to display the elements of the array, we can do it ourselves:

```
public static void printArray(int[] a) {
    System.out.print("{ " + a[0]);
    for (int i = 1; i < a.length; i++) {
        System.out.print(", " + a[i]);
    }
    System.out.println("}");
}
```

Given the previous array, the output of `printArray` is:

```
{1, 2, 3, 4}
```

The Java library includes a class, `java.util.Arrays`, that provides methods for working with arrays. One of them, `toString`, returns a string representation of an array. After importing `Arrays`, we can invoke `toString` like this:

```
System.out.println(Arrays.toString(a));
```

And the output is:

```
[1, 2, 3, 4]
```

Notice that `Arrays.toString` uses square brackets instead of curly braces. But it beats writing your own `printArray` method.

7.4 Copying Arrays

As explained in Section 7.2, array variables contain *references* to arrays. When you make an assignment to an array variable, it simply copies the reference. But it doesn’t copy the array itself. For example:

```
double[] a = new double[3];
double[] b = a;
```

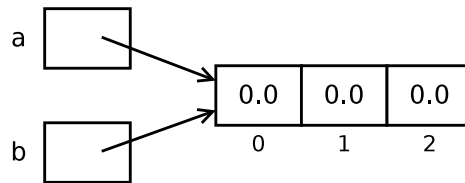

Figure 7.3: Memory diagram of two variables referring to the same array.

These statements create an array of three `double`s and make two different variables refer to it, as shown in Figure 7.3.

Any changes made through either variable will be seen by the other. For example, if we set `a[0] = 17.0`, and then display `b[0]`, the result is `17.0`. Because `a` and `b` are different names for the same thing, they are sometimes called **aliases**.

If you actually want to copy the array, not just the reference, you have to create a new array and copy the elements from one to the other, like this:

```
double[] b = new double[3];
for (int i = 0; i < 3; i++) {
    b[i] = a[i];
}
```

`java.util.Arrays` provides a method named `copyOf` that performs this task for you. So you can replace the previous code with one line:

```
double[] b = Arrays.copyOf(a, 3);
```

The second parameter is the number of elements you want to copy, so `copyOf` can also be used to copy part of an array. Figure 7.4 shows the state of the array variables after invoking `Arrays.copyOf`.

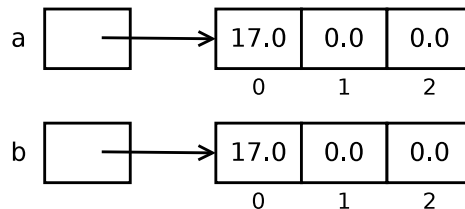

Figure 7.4: Memory diagram of two variables referring to different arrays.

The examples so far only work if the array has three elements. It is better to generalize the code to work with arrays of any size. We can do that by replacing the magic number, 3, with `a.length`:

```
double[] b = new double[a.length];
for (int i = 0; i < a.length; i++) {
    b[i] = a[i];
}
```

All arrays have a built-in constant, `length`, that stores the number of elements. In contrast to `String.length()`, which is a method, `a.length` is a constant. The expression `a.length` may look like a method invocation, but there are no parentheses and no arguments.

The last time the loop gets executed, `i` is `a.length - 1`, which is the index of the last element. When `i` is equal to `a.length`, the condition fails and the body is not executed – which is a good thing, because trying to access `a[a.length]` would throw an exception.

Of course we can replace the loop altogether by using `Arrays.copyOf` and `a.length` for the second argument. The following line produces the same result shown in Figure 7.4.

```
double[] b = Arrays.copyOf(a, a.length);
```

The `Arrays` class provides many other useful methods like `Arrays.compare`, `Arrays.equals`, `Arrays.fill`, and `Arrays.sort`. Take a moment to read the documentation by searching the web for `java.util.Arrays`.

7.5 Array Traversal

Many computations can be implemented by looping through the elements of an array and performing an operation on each element. Looping through the elements of an array is called a **traversal**.

```
int[] a = {1, 2, 3, 4, 5};
for (int i = 0; i < a.length; i++) {
    a[i] *= a[i];
}
```

This example traverses an array and squares each element. At the end of the loop, the array has the values {1, 4, 9, 16, 25}.

Another common pattern is a **search**, which involves traversing an array and “searching” for a particular element. For example, the following method takes an array and a value, and it returns the index where the value appears:

```
public static int search(double[] array, double target) {
    for (int i = 0; i < array.length; i++) {
        if (array[i] == target) {
            return i;
        }
    }
    return -1; // not found
}
```

If we find the target value in the array, we return its index immediately. If the loop exits without finding the target, it returns -1, a special value chosen to indicate a failed search. (This code is essentially what the `String.indexOf` method does.)

The following code searches an array for the value 1.23, which is the third element. Because array indexes start at zero, the output is 2.

```
double[] array = {3.14, -55.0, 1.23, -0.8};
int index = search(array, 1.23);
System.out.println(index);
```

Another common traversal is a **reduce** operation, which “reduces” an array of values down to a single value. Examples include the sum or product of the elements, the minimum, and the maximum. The following method takes an array and returns the sum of its elements:

```
public static double sum(double[] array) {
    double total = 0.0;
    for (int i = 0; i < array.length; i++) {
        total += array[i];
    }
    return total;
}
```

Before the loop, we initialize `total` to zero. Each time through the loop, we update `total` by adding one element from the array. At the end of the loop, `total` contains the sum of the elements. A variable used this way is sometimes called an **accumulator**, because it “accumulates” the running total.

7.6 Random Numbers

Most computer programs do the same thing every time they run; programs like that are called **deterministic**. Usually determinism is a good thing, since we expect the same calculation to yield the same result. But for some applications, we want the computer to be unpredictable. Games are an obvious example, but there are many others, like scientific simulations.

Making a program **nondeterministic** turns out to be hard, because it’s impossible for a computer to generate truly random numbers. But there are algorithms that generate unpredictable sequences called **pseudorandom** numbers. For most applications, they are as good as random.

If you did Exercise 3.4, you have already seen `java.util.Random`, which generates pseudorandom numbers. The method `nextInt` takes an integer argument, `n`, and returns a random integer between 0 and `n - 1` (inclusive).

If you generate a long series of random numbers, every value should appear, at least approximately, the same number of times. One way to test this behavior of `nextInt` is to generate a large number of values, store them in an array, and count the number of times each value occurs.

The following method creates an `int` array and fills it with random numbers between 0 and 99. The argument specifies the desired size of the array, and the return value is a reference to the new array.

```
public static int[] randomArray(int size) {
    Random random = new Random();
    int[] a = new int[size];
    for (int i = 0; i < a.length; i++) {
        a[i] = random.nextInt(100);
    }
    return a;
}
```

The following `main` method generates an array and displays it using `printArray` from Section 7.3. We could have used `Arrays.toString`, but we like seeing curly braces instead of square brackets.

```
public static void main(String[] args) {
    int[] array = randomArray(8);
    printArray(array);
}
```

Each time you run the program, you should get different values. The output will look something like this:

```
{15, 62, 46, 74, 67, 52, 51, 10}
```

7.7 Building a Histogram

If these values were exam scores – and they would be pretty bad exam scores in that case – the teacher might present them to the class in the form of a **histogram**. In statistics, a histogram is a set of counters that keeps track of the number of times each value appears.

For exam scores, we might have ten counters to keep track of how many students scored in the 90s, the 80s, etc. To do that, we can traverse the array and count the number of elements that fall in a given range.

The following method takes an array and two integers. It returns the number of elements that fall in the range from `low` to `high - 1`.

```
public static int inRange(int[] a, int low, int high) {
    int count = 0;
    for (int i = 0; i < a.length; i++) {
        if (a[i] >= low && a[i] < high) {
            count++;
        }
    }
    return count;
}
```

This pattern should look familiar: it is another reduce operation. Notice that `low` is included in the range (`>=`), but `high` is excluded (`<`). This design keeps us from counting any scores twice.

Now we can count the number of scores in each grade range. We add the following code to our `main` method:

```
int[] scores = randomArray(30);
int a = inRange(scores, 90, 100);
int b = inRange(scores, 80, 90);
int c = inRange(scores, 70, 80);
int d = inRange(scores, 60, 70);
int f = inRange(scores, 0, 60);
```

This code is repetitive, but it is acceptable as long as the number of ranges is small. Suppose we wanted to keep track of the number of times each individual score appears. Then we would have to write 100 lines of code:

```
int count0 = inRange(scores, 0, 1);
int count1 = inRange(scores, 1, 2);
int count2 = inRange(scores, 2, 3);
...
int count99 = inRange(scores, 99, 100);
```

What we need is a way to store 100 counters, preferably so we can use an index to access them. Wait a minute, that's exactly what an array does.

The following fragment creates an array of 100 counters, one for each possible score. It loops through the scores and uses `inRange` to count how many times each score appears. Then it stores the results in the `counts` array:

```
int[] counts = new int[100];
for (int i = 0; i < counts.length; i++) {
    counts[i] = inRange(scores, i, i + 1);
}
```

Notice that we are using the loop variable `i` three times: as an index into the `counts` array, and in the last two arguments of `inRange`.

The code works, but it is not as efficient as it could be. Every time the loop invokes `inRange`, it traverses the entire array. It would be better to make a single pass through the `scores` array.

For each score, we already know which range it falls in – the score itself. We can use that value to increment the corresponding counter. This code traverses the array of scores *only once* to generate the histogram:

```
int[] counts = new int[100];
for (int i = 0; i < scores.length; i++) {
    int index = scores[i];
    counts[index]++;
}
```

Each time through the loop, it selects one element from `scores` and uses it as an index to increment the corresponding element of `counts`. Because this code traverses the array of scores only once, it is much more efficient.

7.8 The Enhanced for Loop

Since traversing arrays is so common, Java provides an alternative syntax that makes the code more compact. Consider a `for` loop that displays the elements of an array on separate lines:

```
for (int i = 0; i < values.length; i++) {
    int value = values[i];
    System.out.println(value);
}
```

We could rewrite the loop like this:

```
for (int value : values) {
    System.out.println(value);
}
```

This statement is called an **enhanced for loop**, also known as the “for each” loop. You can read the code as, “for each `value` in `values`”. It’s conventional to use plural nouns for array variables and singular nouns for element variables.

Notice how the single line `for (int value : values)` replaces the first two lines of the standard `for` loop. It hides the details of iterating each index of the array, and instead, focuses on the values themselves.

Using the enhanced `for` loop, and removing the temporary variable, we can write the histogram code from the previous section more concisely:

```
int[] counts = new int[100];
for (int score : scores) {
    counts[score]++;
}
```

Enhanced `for` loops often make the code more readable, especially for accumulating values. But they are not helpful when you need to refer to the index, as in search operations.

```
for (double d : array) {
    if (d == target) {
        // array contains d, but we don't know where
    }
}
```

7.9 Counting Characters

We now return to the example from the beginning of the chapter and present a solution to Exercise 6.5 using arrays. Here is the problem again:

A word is said to be a “doubloon” if every letter that appears in the word appears exactly twice. Write a method called `isDoubloon` that takes a string and checks whether it is a doubloon. To ignore case, invoke the `toLowerCase` method before checking.

Based on the approach from Section 7.7, we will create an array of 26 integers to count how many times each letter appears. We convert the string to lowercase, so that we can treat `'A'` and `'a'` (for example) as the same letter.

```
int[] counts = new int[26];
String lower = s.toLowerCase();
```

We can use a `for` loop to iterate each character in the string. To update the `counts` array, we need to compute the index that corresponds to each character. Fortunately, Java allows you to perform arithmetic on characters.

```
for (int i = 0; i < lower.length(); i++) {
    char letter = lower.charAt(i);
    int index = letter - 'a';
    counts[index]++;
}
```

If `letter` is `'a'`, the value of `index` is 0; if `letter` is `'b'`, the value of `index` is 1, and so on.

Then we use `index` to increment the corresponding element of `counts`. At the end of the loop, `counts` contains a histogram of the letters in the string `lower`.

We can simplify this code with an enhanced `for` loop, but it doesn't work with strings; we have to convert `lower` to an array of characters, like this:

```
for (char letter : lower.toCharArray()) {
    int index = letter - 'a';
    counts[index]++;
}
```

Once we have the counts, we can use a second `for` loop to check whether each letter appears 0 or 2 times.

```
for (int count : counts) {
    if (count != 0 && count != 2) {
        return false; // not a doubleton
    }
}
return true; // is a doubleton
```

If we find a count that is neither 0 or 2, we know the word is not a doubleton and we can return immediately. If we make it all the way through the `for` loop, we know that all counts are 0 or 2, which means the word is a doubleton.

Pulling together the code fragments, and adding some comments and test cases, here's the entire program.

```
public class Doubloon {

    public static boolean isDoubloon(String s) {
        // count the number of times each letter appears
        int[] counts = new int[26];
        String lower = s.toLowerCase();
        for (char letter : lower.toCharArray()) {
            int index = letter - 'a';
            counts[index]++;
        }
        // determine whether the given word is a doubloon
        for (int count : counts) {
            if (count != 0 && count != 2) {
                return false;
            }
        }
        return true;
    }

    public static void main(String[] args) {
        System.out.println(isDoubloon("Mama")); // true
        System.out.println(isDoubloon("Lama")); // false
    }
}
```

This example uses methods, **if** statements, **for** loops, arithmetic and logical operators, integers, characters, strings, booleans, and arrays. We hope you'll take a second to appreciate how much you've learned!

7.10 Vocabulary

array: A collection of values, where all the values have the same type, and each value is identified by an index.

element: One of the values in an array. The `[]` operator selects elements.

index: An integer variable or value used to indicate an element of an array.

allocate: To reserve memory for an array or other object. In Java, the `new` operator allocates memory.

reference: A value that indicates a storage location. In a memory diagram, a reference appears as an arrow.

alias: A variable that refers to the same object as another variable.

traversal: Looping through the elements of an array (or other collection).

search: A traversal pattern used to find a particular element of an array.

reduce: A traversal pattern that combines the elements of an array into a single value.

accumulator: A variable used to accumulate results during a traversal.

deterministic: A program that does the same thing every time it is run.

nondeterministic: A program that always behaves differently, even when run multiple times with the same input.

pseudorandom: A sequence of numbers that appear to be random, but which are actually the product of a deterministic computation.

histogram: An array of integers where each integer counts the number of values that fall into a certain range.

enhanced for loop: An alternative syntax for traversing the elements of an array (or other collection).

7.11 Exercises

The code for this chapter is in the `ch07` directory of `ThinkJavaCode2`. See page xix for instructions on how to download the repository. Before you start the exercises, we recommend that you compile and run the examples.

If you haven't already, take a look at Appendix D where we've collected some of our favorite debugging advice. It refers to language features we haven't yet covered, but it's good for you to know what's available when you need it.

Exercise 7.1 The purpose of this exercise is to practice reading code and recognizing the traversal patterns in this chapter. The following methods are hard to read, because instead of using meaningful names for the variables and methods, they use names of fruit.

For each method, write one sentence that describes what the method does, without getting into the details of how it works. And for each variable, identify the role it plays.

```
public static int banana(int[] a) {
    int kiwi = 1;
    int i = 0;
    while (i < a.length) {
        kiwi = kiwi * a[i];
        i++;
    }
    return kiwi;
}
```

```
public static int grapefruit(int[] a, int grape) {
    for (int i = 0; i < a.length; i++) {
        if (a[i] == grape) {
            return i;
        }
    }
    return -1;
}
```

```
public static int pineapple(int[] a, int apple) {
    int pear = 0;
    for (int pine: a) {
        if (pine == apple) {
            pear++;
        }
    }
    return pear;
}
```

Exercise 7.2 What is the output of the following program? Describe in a few words what `mus` does. Draw a stack diagram just before `mus` returns.

```
public static int[] make(int n) {
    int[] a = new int[n];
    for (int i = 0; i < n; i++) {
        a[i] = i + 1;
    }
    return a;
}
```

```
public static void dub(int[] jub) {
    for (int i = 0; i < jub.length; i++) {
        jub[i] *= 2;
    }
}
```

```
public static int mus(int[] zoo) {
    int fus = 0;
    for (int i = 0; i < zoo.length; i++) {
        fus += zoo[i];
    }
    return fus;
}
```

```
public static void main(String[] args) {
    int[] bob = make(5);
    dub(bob);
    System.out.println(mus(bob));
}
```

Exercise 7.3 Write a method called `indexOfMax` that takes an array of integers and returns the index of the largest element. Can you write this method using an enhanced `for` loop? Why or why not?

Exercise 7.4 The Sieve of Eratosthenes is “a simple, ancient algorithm for finding all prime numbers up to any given limit,” which you can read about at https://en.wikipedia.org/wiki/Sieve_of_Eratosthenes.

Write a method called `sieve` that takes an integer parameter, `n`, and returns a `boolean` array that indicates, for each number from 0 to `n - 1`, whether the number is prime.

Exercise 7.5 Write a method named `areFactors` that takes an integer `n` and an array of integers, and that returns `true` if the numbers in the array are all factors of `n` (which is to say that `n` is divisible by all of them).

Exercise 7.6 Write a method named `arePrimeFactors` that takes an integer `n` and an array of integers, and that returns `true` if the numbers in the array are all prime *and* their product is `n`.

Exercise 7.7 Write a method called `letterHist` that takes a string as a parameter and returns a histogram of the letters in the string. The zeroth element of the histogram should contain the number of a's in the string (upper- and lowercase); the 25th element should contain the number of z's. Your solution should only traverse the string once.

Exercise 7.8 Two words are anagrams if they contain the same letters and the same number of each letter. For example, “stop” is an anagram of “pots”, “allen downey” is an anagram of “well annoyed”, and “christopher mayfield” is an anagram of “hi prof the camel is dry”. Write a method that takes two strings and checks whether they are anagrams of each other.

Chapter 8

Recursive Methods

Up to this point, we've been using `while` and `for` loops whenever we've needed to repeat something. Methods that use iteration are called **iterative**. They are straight-forward, but sometimes there are more elegant solutions.

In this chapter, we explore one of the most magical things that a method can do: invoke *itself* to solve a smaller version of the *same* problem. A method that invokes itself is called **recursive**.

8.1 Recursive Void Methods

Consider the following example:

```
public static void countdown(int n) {
    if (n == 0) {
        System.out.println("Blastoff!");
    } else {
        System.out.println(n);
        countdown(n - 1);
    }
}
```

The name of the method is `countdown`; it takes a single integer as a parameter. If the parameter is zero, it displays the word “Blastoff”. Otherwise, it displays the number and then invokes itself, passing `n - 1` as the argument.

What happens if we invoke `countdown(3)` from `main`?

The execution of `countdown` begins with `n == 3`, and since `n` is not zero, it displays the value 3, and then invokes itself...

The execution of `countdown` begins with `n == 2`, and since `n` is not zero, it displays the value 2, and then invokes itself...

The execution of `countdown` begins with `n == 1`, and since `n` is not zero, it displays the value 1, and then invokes itself...

The execution of `countdown` begins with `n == 0`, and since `n` is zero, it displays the word “Blastoff!” and then returns.

The `countdown` that got `n == 1` returns.

The `countdown` that got `n == 2` returns.

The `countdown` that got `n == 3` returns.

And then you’re back in `main`. So the total output looks like:

```
3
2
1
Blastoff!
```

As a second example, we’ll rewrite the methods `newLine` and `threeLine` from Section 4.1. Here they are again:

```
public static void newLine() {
    System.out.println();
}

public static void threeLine() {
    newLine();
    newLine();
    newLine();
}
```

Although these methods work, they would not help if we wanted to display two newlines, or maybe 100. A more general alternative would be:

```
public static void nLines(int n) {  
    if (n > 0) {  
        System.out.println();  
        nLines(n - 1);  
    }  
}
```

This method takes an integer, n , as a parameter and displays n newlines. The structure is similar to `countdown`. As long as n is greater than zero, it displays a newline and then invokes itself to display $(n - 1)$ additional newlines. The total number of newlines is $1 + (n - 1)$, which is just what we wanted: n .

8.2 Recursive Stack Diagrams

In Section 4.5, we used a stack diagram to represent the state of a program during a method invocation. The same kind of diagram can make it easier to interpret a recursive method.

Remember that every time a method gets called, Java creates a new frame that contains the method's parameters and variables. Figure 8.1 is a stack diagram for `countdown`, called with `n == 3`.

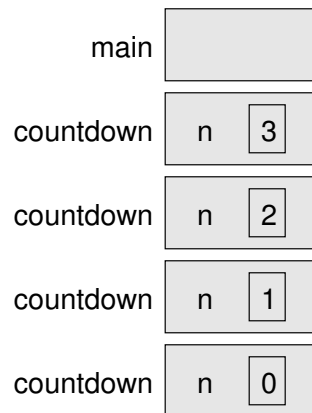

Figure 8.1: Stack diagram for the `countdown` program.

By convention, the frame for `main` is at the top, and the stack of other frames grows down. That way, we can draw stack diagrams on paper without needing to guess how far they will grow. The frame for `main` is empty because `main`

does not have any variables. (It has the parameter `args`, but since we're not using it, we left it out of the diagram.)

There are four frames for `countdown`, each with a different value for the parameter `n`. The last frame, with `n == 0`, is called the **base case**. It does not make a recursive call, so there are no more frames below it.

If there is no base case in a recursive method, or if the base case is never reached, the stack would grow forever – at least in theory. In practice, the size of the stack is limited. If you exceed the limit, you get a `StackOverflowError`.

For example, here is a recursive method without a base case:

```
public static void forever(String s) {
    System.out.println(s);
    forever(s);
}
```

This method displays the given string until the stack overflows, at which point it throws an error. Try this example on your computer – you might be surprised by how long the error message is!

8.3 Value-Returning Methods

To give you an idea of what you can do with the tools we have learned, let's look at methods that evaluate recursively-defined mathematical functions.

A recursive definition is similar to a “circular” definition, in the sense that the definition refers to the thing being defined. Of course, a truly circular definition is not very useful:

recursive:

An adjective used to describe a method that is recursive.

If you saw that definition in the dictionary, you might be annoyed. Then again, if you search for “recursion” on Google, it displays “Did you mean: recursion” as an inside joke. People fall for that link all the time.

Many mathematical functions are defined recursively, because that is often the simplest way. For example, the **factorial** of an integer n , which is written $n!$, is defined like this:

$$\begin{aligned}0! &= 1 \\ n! &= n \cdot (n - 1)!\end{aligned}$$

Don't confuse the mathematical symbol $!$, which means *factorial*, with the Java operator $!$, which means *not*. This definition says that `factorial(0)` is 1, and `factorial(n)` is `n * factorial(n - 1)`.

So `factorial(3)` is `3 * factorial(2)`; `factorial(2)` is `2 * factorial(1)`; `factorial(1)` is `1 * factorial(0)`; and `factorial(0)` is 1. Putting it all together, we get `3 * 2 * 1 * 1`, which is 6.

If you can formulate a recursive definition of something, you can easily write a Java method to evaluate it. The first step is to decide what the parameters and return type are. Since factorial is defined for integers, the method takes an `int` as a parameter and returns an `int`.

```
public static int factorial(int n) {
    return 0; // stub
}
```

Next, we think about the base case. If the argument happens to be zero, we return 1.

```
public static int factorial(int n) {
    if (n == 0) {
        return 1;
    }
    return 0; // stub
}
```

Otherwise, and this is the interesting part, we have to make a recursive call to find the factorial of $n - 1$, and then multiply it by n .

```
public static int factorial(int n) {  
    if (n == 0) {  
        return 1;  
    }  
    int recurse = factorial(n - 1);  
    int result = n * recurse;  
    return result;  
}
```

To illustrate what is happening, we'll use the temporary variables `recurse` and `result`. In each method call, `recurse` stores the factorial of $n - 1$, and `result` stores the factorial of n .

The flow of execution for this program is similar to `countdown` from Section 8.1. If we invoke `factorial` with the value 3:

Since 3 is not zero, we skip the first branch and calculate the factorial of $n - 1$...

Since 2 is not zero, we skip the first branch and calculate the factorial of $n - 1$...

Since 1 is not zero, we skip the first branch and calculate the factorial of $n - 1$...

Since 0 is zero, we take the first branch and return the value 1 immediately.

The return value (1) gets multiplied by `n`, which is 1, and the result is returned.

The return value (1) gets multiplied by `n`, which is 2, and the result is returned.

The return value (2) gets multiplied by `n`, which is 3, and the result, 6, is returned to whatever invoked `factorial(3)`.

Figure 8.2 shows what the stack diagram looks like for this sequence of method invocations. The return values are shown being passed up the stack. Notice that `recurse` and `result` do not exist in the last frame, because when `n == 0` the code that declares them does not execute.

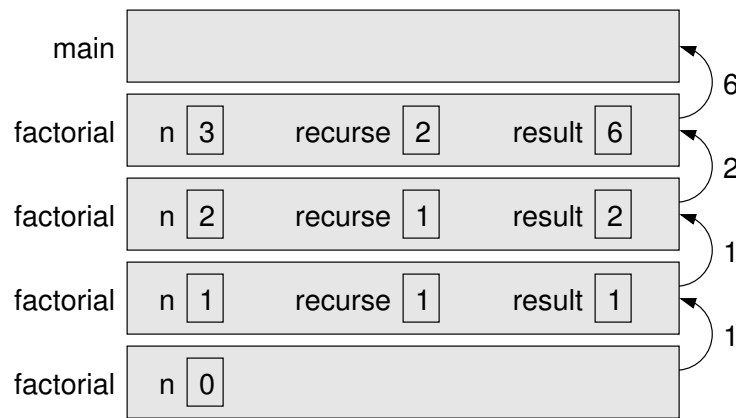
Figure 8.2: Stack diagram for the `factorial` method.

8.4 The Leap of Faith

Following the flow of execution is one way to read programs, but it can quickly become overwhelming. Another way to understand recursion is the **leap of faith**: when you come to a method invocation, instead of following the flow of execution, you *assume* that the method works correctly and returns the appropriate value.

In fact, you are already practicing this leap of faith when you use methods in the Java library. When you invoke `Math.cos` or `System.out.println`, you don't think about the implementations of those methods. You just assume that they work properly.

The same is true of other methods. For example, consider the method from Section 5.8 that determines whether an integer has only one digit:

```
public static boolean isSingleDigit(int x) {
    return x > -10 && x < 10;
}
```

Once you convince yourself that this method is correct – by examining and testing the code – you can just use the method without ever looking at the implementation again.

Recursive methods are no different. When you get to a recursive call, don't think about the flow of execution. Instead, *assume* that the recursive call produces the desired result.

For example, “Assuming that I can find the factorial of $n-1$, can I compute the factorial of n ?” Yes you can, by multiplying by n . Here’s an implementation of `factorial` with the temporary variables removed:

```
public static int factorial(int n) {
    if (n == 0) {
        return 1;
    }
    return n * factorial(n - 1);
}
```

Notice how similar this version is to the original mathematical definition:

$$0! = 1$$
$$n! = n \cdot (n - 1)!$$

Of course, it is strange to assume that the method works correctly when you have not finished writing it. But that’s why it’s called a leap of faith!

Another common recursively-defined mathematical function is the Fibonacci sequence, which has the following definition:

$$fibonacci(1) = 1$$
$$fibonacci(2) = 1$$
$$fibonacci(n) = fibonacci(n - 1) + fibonacci(n - 2)$$

Notice that each Fibonacci number is the sum of the two preceding Fibonacci numbers. Translated into Java, this function is:

```
public static int fibonacci(int n) {
    if (n == 1 || n == 2) {
        return 1;
    }
    return fibonacci(n - 1) + fibonacci(n - 2);
}
```

If you try to follow the flow of execution here, even for small values of `n`, your head will explode. But if we take a leap of faith and assume that the two recursive invocations work correctly, then it is clear, looking at the definition, that our implementation is correct.

8.5 Counting Up Recursively

The `countdown` example in Section 8.1 has three parts: (1) it checks the base case, (2) it displays something, and (3) it makes a recursive call. What do you think happens if you reverse steps (2) and (3), making the recursive call *before* displaying?

```
public static void countup(int n) {
    if (n == 0) {
        System.out.println("Blastoff!");
    } else {
        countup(n - 1);
        System.out.println(n);
    }
}
```

The stack diagram is the same as before, and the method is still called n times. But now the `System.out.println` happens just before each recursive call returns. As a result, it counts *up* instead of down:

```
Blastoff!
1
2
3
```

Keep this in mind for the next example, which displays numbers in binary.

8.6 Binary Number System

You are probably aware that computers can only store 1's and 0's. That's because processors and memory are made up of billions of tiny on-off switches.

The value 1 means a switch is on; the value 0 means a switch is off. All types of data, whether integer, floating-point, text, audio, video, or something else, are represented by 1's and 0's.

Fortunately, we can represent any integer as a **binary** number. The following table shows the first eight numbers in binary and decimal.

Binary	Decimal
0	0
1	1
10	2
11	3
100	4
101	5
110	6
111	7

Table 8.1: The first eight binary numbers.

In decimal there are 10 digits, and the written representation of numbers is based on powers of 10. For example, the number 456 has 4 in the 100's place, 5 in the 10's place, and 6 in the 1's place. So the value is $400 + 50 + 6$.

4	5	6
10^2	10^1	10^0

In binary there are 2 digits, and the written representation of numbers is based on powers of 2. For example, the number 10111 has 1 in the 16's place, 0 in the 8's place, 1 in the 4's place, 1 in the 2's place, and 1 in the 1's place. So the value is $16 + 0 + 4 + 2 + 1$, which is 23 in decimal.

1	0	1	1	1
2^4	2^3	2^2	2^1	2^0

To get the digits of a decimal number, we can use repeated division. For example, if we divide 456 by 10, we get 45 with remainder 6. The remainder is the rightmost digit of 456.

If we divide the result again, we get 4 with remainder 5. The remainder is the second rightmost digit of 456. And if we divide again, we get 0 with remainder 4. The remainder is the third rightmost digit of 456, and the result, 0, tells us that we're done.

We can do the same thing in binary if we divide by two. When you divide by two, the remainder is the right-most digit, either 0 or 1. If you divide the result again, you get the second rightmost digit. If you keep going, and write down the remainders, you'll have your number in binary.

```
23 / 2 is 11 remainder 1
11 / 2 is 5 remainder 1
 5 / 2 is 2 remainder 1
 2 / 2 is 1 remainder 0
 1 / 2 is 0 remainder 1
```

Reading these remainders from bottom to top, 23 in binary is 10111.

8.7 Recursive Binary Method

Now, to display a number in binary we can combine the algorithm from the previous section and the “count up” pattern from Section 8.5.

Here is a recursive method that displays any positive integer in binary:

```
public static void displayBinary(int value) {
    if (value > 0) {
        displayBinary(value / 2);
        System.out.print(value % 2);
    }
}
```

If `value` is zero, `displayBinary` does nothing (that's the base case). If the argument is positive, the method divides it by two and calls `displayBinary` recursively. When the recursive call returns, the method displays one digit of the result and returns (again). Figure 8.3 illustrates this process.

The leftmost digit is near the bottom of the stack, so it gets displayed first. The rightmost digit, near the top of the stack, gets displayed last. After invoking `displayBinary`, we use `println` to complete the output.

```
displayBinary(23);    // output is 10111
System.out.println();
```

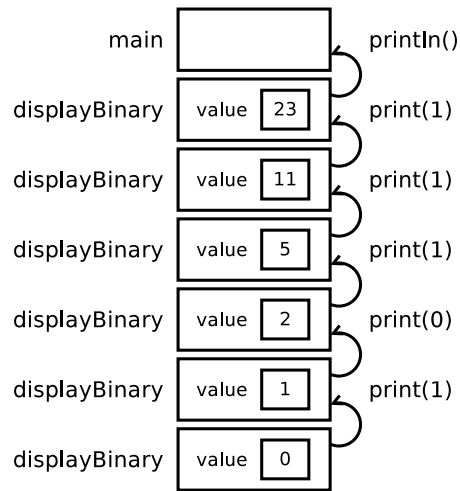

Figure 8.3: Stack diagram for the `displayBinary` method.

8.8 CodingBat Problems

In the past several chapters you've seen methods, conditions, loops, strings, arrays, and recursion. A great resource for practicing all of these concepts is <https://codingbat.com/>.

CodingBat is a free website of programming problems developed by Nick Parlante, a Computer Science lecturer at Stanford University. As you work on these problems, CodingBat saves your progress (if you create an account).

To conclude this chapter, we consider two problems in the `Recursion-1` section of CodingBat. One of them deals with strings, and the other deals with arrays. Both of them have the same recursive idea: check the base case, look at the current index, and recursively handle the rest.

The first problem is available at <https://codingbat.com/prob/p118230>:

Recursion-1 noX

Given a string, compute recursively a new string where all the `'x'` chars have been removed.

```
noX("xaxb") → "ab"
noX("abc") → "abc"
noX("xx") → ""
```

When solving recursive problems, it helps to think about the base case first. The base case is the easiest version of the problem; for `noX`, it's the empty string. If the argument is an empty string, there are no `x`'s to be removed.

```
if (str.length() == 0) {
    return "";
}
```

Next comes the more difficult part. To solve a problem recursively, you need to think of a simpler instance of the same problem. For `noX`, it's removing all the `x`'s from a shorter string.

So let's split the string into two parts, the first letter and the rest.

```
char first = str.charAt(0);
String rest = str.substring(1);
```

Now we can make a recursive call to remove the `x`'s from `rest`:

```
String recurse = noX(rest);
```

If `first` happens to be an `x`, we're done; we just have to return `recurse`. Otherwise, we have to concatenate `first` and `recurse`. Here's the `if` statement we need.

```
if (first == 'x') {
    return recurse;
} else {
    return first + recurse;
}
```

You can run this solution on CodingBat by pasting these snippets into the provided method definition.

The second problem is available at <https://codingbat.com/prob/p135988>:

Recursion-1 array11

Given an array of ints, compute recursively the number of times that the value 11 appears in the array.

```
array11([1, 2, 11], 0) → 1
array11([11, 11], 0) → 2
array11([1, 2, 3, 4], 0) → 0
```

This problem uses the convention of passing the index as an argument. So the base case is when we've reached the end of the array. At that point, we know there are no more 11's.

```
if (index >= nums.length) {  
    return 0;  
}
```

Next we look at the current number (based on the given index), and check if it's an 11. After that, we can recursively check the rest of the array. Similar to the noX problem, we look at only one integer per method call.

```
int recurse = array11(nums, index + 1);  
if (nums[index] == 11) {  
    return recurse + 1;  
} else {  
    return recurse;  
}
```

Again, you can run this solutions on CodingBat by pasting the snippets into the method definition.

To see how these solutions actually work, you might find it helpful to step through them with a debugger (see Appendix A.6) or Java Tutor (<https://thinkjava.org/javatutor>). Then try solving other CodingBat problems on your own.

Learning to think recursively is an important part of learning to think like a computer scientist. Many algorithms can be written concisely with recursive methods that perform computations on the way down, on the way up, or both.

8.9 Vocabulary

iterative: A method or algorithm that repeats steps using one or more loops.

recursive: A method or algorithm that invokes itself one or more times with different arguments.

base case: A condition that causes a recursive method *not* to make another recursive call.

factorial: The product of all the integers up to and including a given integer.

leap of faith: A way to read recursive programs by assuming that the recursive call works, rather than following the flow of execution.

binary: A system that uses only zeros and ones to represent numbers. Also known as “base 2”.

8.10 Exercises

The code for this chapter is in the `ch08` directory of `ThinkJavaCode2`. See page xix for instructions on how to download the repository. Before you start the exercises, we recommend that you compile and run the examples.

If you have not already read Appendix A.7, now might be a good time. It describes JUnit, a standard framework for writing test code.

Exercise 8.1 The purpose of this exercise is to take a problem and break it into smaller problems, and to solve the smaller problems by writing simple methods. Consider the first verse of the song “99 Bottles of Beer”:

```
99 bottles of beer on the wall,  
99 bottles of beer,  
ya' take one down, ya' pass it around,  
98 bottles of beer on the wall.
```

Subsequent verses are identical except that the number of bottles gets smaller by one in each verse, until the last verse:

```
No bottles of beer on the wall,  
no bottles of beer,  
ya' can't take one down, ya' can't pass it around,  
'cause there are no more bottles of beer on the wall!
```

And then the song (finally) ends.

Write a program that displays the entire lyrics of “99 Bottles of Beer”. Your program should include a recursive method that does the hard part, but you might want to write additional methods to separate other parts of the program. As you develop your code, test it with a small number of verses, like 3.

Exercise 8.2 Write a recursive method named `oddSum` that takes a positive odd integer `n` and returns the sum of odd integers from 1 to `n`. Start with a base case, and use temporary variables to debug your solution. You might find it helpful to print the value of `n` each time `oddSum` is invoked.

Exercise 8.3 In this exercise, you will use a stack diagram to understand the execution of the following recursive method.

```
public static void main(String[] args) {
    System.out.println(prod(1, 4));
}

public static int prod(int m, int n) {
    if (m == n) {
        return n;
    } else {
        int recurse = prod(m, n - 1);
        int result = n * recurse;
        return result;
    }
}
```

1. Draw a stack diagram showing the state of the program just before the last invocation of `prod` completes.
2. What is the output of this program? (Try to answer this question on paper first, then run the code to check your answer.)
3. Explain in a few words what `prod` does (without getting into the details of how it works).
4. Rewrite `prod` without the temporary variables `recurse` and `result`.
Hint: You only need one line for the `else` branch.

Exercise 8.4 The goal of this exercise is to translate a recursive definition into a Java method. The Ackermann function is defined for non-negative integers as follows:

$$A(m, n) = \begin{cases} n + 1 & \text{if } m = 0 \\ A(m - 1, 1) & \text{if } m > 0 \text{ and } n = 0 \\ A(m - 1, A(m, n - 1)) & \text{if } m > 0 \text{ and } n > 0 \end{cases}$$

Write a recursive method called `ack` that takes two `ints` as parameters and that computes and returns the value of the Ackermann function.

Test your implementation of Ackermann by invoking it from `main` and displaying the return value. Note the return value gets very big very quickly. You should try it only for small values of m and n (not bigger than 3).

Exercise 8.5 Write a recursive method called `power` that takes a double `x` and an integer `n` and returns x^n .

Hint: A recursive definition of this operation is $x^n = x \cdot x^{n-1}$. Also, remember that anything raised to the zeroth power is 1.

Optional challenge: you can make this method more efficient, when `n` is even, using $x^n = (x^{n/2})^2$.

Exercise 8.6 Many of the patterns we have seen for traversing arrays can also be written recursively. It is not common, but it is a useful exercise.

1. Write a method called `maxInRange` that takes an array of integers and two indexes, `lowIndex` and `highIndex`, and finds the maximum value in the array, but only considering the elements between `lowIndex` and `highIndex`, including both.

This method should be recursive. If the length of the range is 1, that is, if `lowIndex == highIndex`, we know immediately that the sole element in the range must be the maximum. So that's the base case.

If there is more than one element in the range, we can break the array into two pieces, find the maximum in each of the pieces, and then find the maximum of the maxima.

2. Methods like `maxInRange` can be awkward to use. To find the largest element in an array, we have to provide the range for the entire array.

```
double max = maxInRange(a, 0, a.length - 1);
```

Write a method called `max` that takes an array and uses `maxInRange` to find and return the largest element.

Exercise 8.7 Create a program called `Recurse.java` and type in the following methods:

```
/**
 * Returns the first character of the given String.
 */
public static char first(String s) {
    return s.charAt(0);
}
```

```
/**
 * Returns all but the first letter of the given String.
 */
public static String rest(String s) {
    return s.substring(1);
}
```

```
/**
 * Returns all but the first and last letter of the String.
 */
public static String middle(String s) {
    return s.substring(1, s.length() - 1);
}
```

```
/**
 * Returns the length of the given String.
 */
public static int length(String s) {
    return s.length();
}
```

1. Write some code in `main` that tests each of these methods. Make sure they work, and you understand what they do.
2. Using these methods, and without using any other `String` methods, write a method called `printString` that takes a string as a parameter and that displays the letters of the string, one on each line. It should be a void method.

3. Again using only these methods, write a method called `printBackward` that does the same thing as `printString` but that displays the string backward (again, one character per line).
4. Now write a method called `reverseString` that takes a string as a parameter and that returns a new string as a return value. The new string should contain the same letters as the parameter, but in reverse order.

```
String backwards = reverseString("coffee");  
System.out.println(backwards);
```

The output of this example code should be:

```
eeffoc
```

5. A palindrome is a word that reads the same both forward and backward, like “otto” and “palindromeemordnilap”. Here’s one way to test whether a string is a palindrome:

A single letter is a palindrome, a two-letter word is a palindrome if the letters are the same, and any other word is a palindrome if the first letter is the same as the last and the middle is a palindrome.

Write a recursive method named `isPalindrome` that takes a `String` and returns a `boolean` indicating whether the word is a palindrome.

Chapter 9

Immutable Objects

Java is an **object-oriented** language, which means that it uses objects to (1) represent data and (2) provide methods related to them. This way of organizing programs is a powerful design concept, and we will introduce it gradually throughout the remainder of the book.

An **object** is a collection of data that provides a set of methods. For example, `Scanner`, which we saw in Section 3.2, is an object that provides methods for parsing input. `System.out` and `System.in` are also objects.

Strings are objects, too. They contain characters and provide methods for manipulating character data. Other data types, like `Integer`, contain numbers and provide methods for manipulating number data. We will explore some of these methods in this chapter.

9.1 Primitives vs Objects

Not everything in Java is an object: `int`, `double`, `char`, and `boolean` are **primitive** types. When you declare a variable with a primitive type, Java reserves a small amount of memory to store its value. Figure 9.1 shows how the following values are stored in memory.

```
int number = -2;  
char symbol = '!';
```

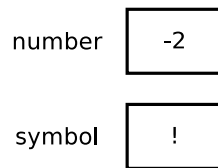

Figure 9.1: Memory diagram of two primitive variables.

As we learned in Section 7.2, an array variable stores a *reference* to an array. For example, the following line declares a variable named `array` and creates an array of three characters.

```
char[] array = {'c', 'a', 't'};
```

Figure 9.2 shows them both, with a box to represent the location of the variable and an arrow pointing to the location of the array.

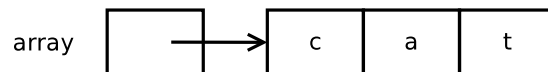
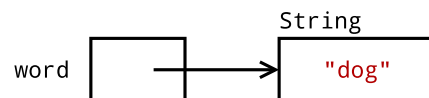

Figure 9.2: Memory diagram of an array of characters.

Objects work in a similar way. For example, this line declares a `String` variable named `word` and creates a `String` object, as shown in Figure 9.3.

```
String word = "dog";
```

Figure 9.3: Memory diagram of a `String` object.

Objects and arrays are usually created with the `new` keyword, which allocates memory for them. For convenience, you don't have to use `new` to create strings:

```
String word = new String("dog"); // creates a string object
String word = "dog";           // implicitly creates a string object
```

Recall from Section 6.10 that you need to use the `equals` method to compare strings. The `equals` method traverses the `String` objects and tests whether they contain the same characters.

To test whether two integers or other primitive types are equal, you can simply use the `==` operator. But two `String` objects with the same characters would not be considered equal in the `==` sense. The `==` operator, when applied to string variables, only tests whether they refer to the *same* object.

9.2 The null Keyword

Often when you declare an object variable, you assign it to reference an object. But sometimes you want to declare variable that doesn't refer to an object, at least initially.

In Java, the keyword `null` is a special value that means “no object”. You can initialize object and array variables this way:

```
String name = null;
int[] combo = null;
```

The value `null` is represented in memory diagrams by a small box with no arrow, as in Figure 9.4.

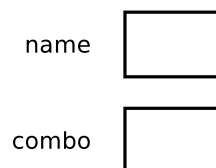

Figure 9.4: Memory diagram showing variables that are `null`.

If you try to use a variable that is `null` by invoking a method or accessing an element, Java throws a `NullPointerException`.

```
System.out.println(name.length()); // NullPointerException
System.out.println(combo[0]);      // NullPointerException
```

On the other hand, it is perfectly fine to pass a `null` reference as an argument to a method, or to receive one as a return value. In these situations, `null` is often used to represent a special condition or indicate an error.

9.3 Strings are Immutable

If the Java library didn't have a `String` class, we would have to use character arrays to store and manipulate text. Operations like concatenation (+), `indexOf`, and `substring` would be difficult and inconvenient. Fortunately, Java does have a `String` class that provides these and other methods.

For example, the methods `toLowerCase` and `toUpperCase` convert uppercase letters to lowercase, and vice versa. These methods are often a source of confusion, because it sounds like they modify strings. But neither these methods nor any others can change a string, because strings are **immutable**.

When you invoke `toUpperCase` on a string, you get a new `String` object as a result. For example:

```
String name = "Alan Turing";
String upperName = name.toUpperCase();
```

After these statements run, `upperName` refers to the string `"ALAN TURING"`. But `name` still refers to `"Alan Turing"`. A common mistake is to assume that `toUpperCase` somehow affects the original string:

```
String name = "Alan Turing";
name.toUpperCase();           // ignores the return value
System.out.println(name);
```

The previous code displays `"Alan Turing"`, because the value of `name`, which refers to the original `String` object, never changes. If you want to change `name` to be uppercase, then you need to assign the return value:

```
String name = "Alan Turing";
name = name.toUpperCase();    // references the new string
System.out.println(name);
```

A similar method is `replace`, which finds and replaces instances of one string within another. This example replaces `"Computer Science"` with `"CS"`:

```
String text = "Computer Science is fun!";
text = text.replace("Computer Science", "CS");
```

As with `toUpperCase`, assigning the return value (to `text`) is important. If you don't assign the return value, invoking `text.replace` has no effect.

Strings are immutable by design, because it simplifies passing them as parameters and return values. And since the contents of a string can never change, two variables can reference the same string without one accidentally corrupting the other.

9.4 Wrapper Classes

Primitive types like `int`, `double`, and `char` cannot be `null`, and they do not provide methods. For example, you can't invoke `equals` on an `int`:

```
int i = 5;
System.out.println(i.equals(5)); // compiler error
```

But for each primitive type, there is a corresponding **wrapper class** in the Java library. The wrapper class for `int` is named `Integer`, with a capital I.

```
Integer i = new Integer(5);
System.out.println(i.equals(5)); // displays true
```

Other wrapper classes include `Boolean`, `Character`, `Double`, and `Long`. They are in the `java.lang` package, so you can use them without importing them.

Like strings, objects from wrapper classes are immutable, and you have to use the `equals` method to compare them.

```
Integer x = new Integer(123);
Integer y = new Integer(123);
if (x == y) { // false
    System.out.println("x and y are the same object");
}
if (x.equals(y)) { // true
    System.out.println("x and y have the same value");
}
```

Because `x` and `y` refer to different objects, this code only displays “x and y have the same value”.

Each wrapper class defines the constants `MIN_VALUE` and `MAX_VALUE`. For example, `Integer.MIN_VALUE` is `-2147483648`, and `Integer.MAX_VALUE` is

2147483647. Because these constants are available in wrapper classes, you don't have to remember them, and you don't have to write them yourself.

Wrapper classes also provide methods for converting strings to and from primitive types. For example, `Integer.parseInt` converts a string to an `int`. In this context, **parse** means “read and translate”.

```
String str = "12345";
int num = Integer.parseInt(str);
```

Other wrapper classes provide similar methods, like `Double.parseDouble` and `Boolean.parseBoolean`. They also provide `toString`, which returns a string representation of a value:

```
int num = 12345;
String str = Integer.toString(num);
```

The result is the `String` object `"12345"`.

It's always possible to convert a primitive value to a string, but not the other way around. For example, if we try to parse an invalid string like this:

```
String str = "five";
int num = Integer.parseInt(str); // NumberFormatException
```

`parseInt` throws a `NumberFormatException`, because the characters in the string `"five"` are not digits.

9.5 Command-Line Arguments

Now that you know about strings, arrays, and wrapper classes, we can *finally* explain the `args` parameter of the `main` method, which we have been ignoring since Chapter 1. If you are unfamiliar with the command-line interface, please read Appendix A.3.

Let's write a program to find the maximum value in a sequence of numbers. Rather than read the numbers from `System.in` using a `Scanner`, we'll pass them as command-line arguments. Here is a starting point:

```
import java.util.Arrays;
public class Max {
    public static void main(String[] args) {
        System.out.println(Arrays.toString(args));
    }
}
```

You can run this program from the command line by typing:

```
java Max
```

The output indicates that `args` is an **empty array**; that is, it has no elements:

```
[]
```

If you provide additional values on the command line, they are passed as arguments to `main`. For example, if you run the program like this:

```
java Max 10 -3 55 0 14
```

The output is:

```
[10, -3, 55, 0, 14]
```

It's not clear from the output, but the elements of `args` are strings. So `args` is the array `{"10", "-3", "55", "0", "14"}`. To find the maximum number, we have to convert the arguments to integers.

The following code uses an enhanced `for` loop (see Section 7.8) to parse the arguments and find the largest value:

```
int max = Integer.MIN_VALUE;
for (String arg : args) {
    int value = Integer.parseInt(arg);
    if (value > max) {
        max = value;
    }
}
System.out.println("The max is " + max);
```

We begin by initializing `max` to the smallest (most negative) number an `int` can represent. That way, the first value we parse will replace `max`. As we find larger values, they will replace `max` as well.

If `args` is empty, the result will be `MIN_VALUE`. We can prevent this situation from happening by checking `args` at the beginning of the program:

```
if (args.length == 0) {
    System.err.println("Usage: java Max <numbers>");
    return;
}
```

It's customary for programs that require command-line arguments to display a “usage” message if the arguments are not valid. For example, if you run `javac` or `java` from the command line without any arguments, you will get a very long message.

9.6 Argument Validation

As we discussed in Section 5.9, you should never assume that program input will be in the correct format. Sometimes users make mistakes, such as pressing the wrong key or misreading instructions.

Or even worse, someone might make intentional “mistakes” to see what your program will do. One way hackers break into computer systems is by entering malicious input that causes a program to fail.

Programmers can make mistakes too. It's difficult to write bug-free software, especially when working in teams on large projects.

For all of these reasons, it's good practice to validate arguments passed to methods, including the `main` method. In the previous section, we did this by ensuring that `args.length` was not zero.

As a further example, consider a method that checks whether the first word of a sentence is capitalized. We can write this method using the `Character` wrapper class:

```
public static boolean isCapitalized(String str) {
    return Character.isUpperCase(str.charAt(0));
}
```

The expression `str.charAt(0)` makes two assumptions: the string object referenced by `str` exists, and it has at least one character. What if these assumptions don't hold at run-time?

- If `str` is `null`, invoking `charAt` will cause a `NullPointerException`, because you can't invoke a method on `null`.
- If `str` refers to an empty string, which is a `String` object with no characters, `charAt` will cause a `StringIndexOutOfBoundsException`, because there is no character at index 0.

We can prevent these exceptions by validating `str` *at the start* of the method. If it's invalid, we return before executing the rest of the method.

```
public static boolean isCapitalized(String str) {
    if (str == null || str.isEmpty()) {
        return false;
    }
    return Character.isUpperCase(str.charAt(0));
}
```

Notice that `null` and “empty” are different concepts, as shown in Figure 9.5. The variable `str1` is `null`, meaning that it doesn't reference an object. The variable `str2` refers to the empty string, an object that exists.

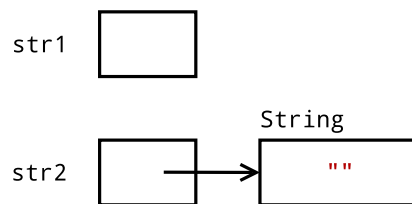

Figure 9.5: Memory diagram of `null` and empty string.

Beginners sometimes make the mistake of checking for empty first. Doing so causes a `NullPointerException`, because you can't invoke methods on variables that are `null`.

```
if (str.isEmpty() || str == null) { // wrong!
```

Checking for `null` first prevents the `NullPointerException`. If `str` is `null`, the `||` operator will short circuit (see Section 5.5) and evaluate to `true` immediately. As a result, `str.isEmpty()` will not be called.

9.7 BigInteger Arithmetic

It might not be clear at this point why you would ever need an integer object when you can just use an `int` or `long`. One advantage is the variety of methods that `Integer` and `Long` provide. But there is another reason: when you need very large integers that exceed `Long.MAX_VALUE`.

`BigInteger` is a Java class that can represent arbitrarily large integers. There is no upper bound except the limitations of memory size and processing speed. Take a minute to read the documentation, which you can find by doing a web search for “Java BigInteger”.

To use BigIntegers, you have to `import java.math.BigInteger` at the beginning of your program. There are several ways to create a `BigInteger`, but the simplest uses `valueOf`. The following code converts a `long` to a `BigInteger`:

```
long x = 17;
BigInteger big = BigInteger.valueOf(x);
```

You can also create `BigIntegers` from strings. For example, here is a 20-digit integer that is too big to store using a `long`.

```
String s = "12345678901234567890";
BigInteger bigger = new BigInteger(s);
```

Notice the difference in the previous two examples: you use `valueOf` to convert integers, and `new BigInteger` to convert strings.

Since `BigIntegers` are not primitive types, the usual math operators don't work. Instead, we have to use methods like `add`. To add two `BigIntegers`, we invoke `add` on one and pass the other as an argument.

```
BigInteger a = BigInteger.valueOf(17);
BigInteger b = BigInteger.valueOf(1700000000);
BigInteger c = a.add(b);
```

Like strings, `BigInteger` objects are immutable. Methods like `add`, `multiply`, and `pow` all return new `BigIntegers`, rather than modify an existing one.

Internally, a `BigInteger` is implemented using an array of `ints`, similar to the way a string is implemented using an array of `chars`. Each `int` in the array

stores a portion of the `BigInteger`. The methods of `BigInteger` traverse this array to perform addition, multiplication, etc.

For very long floating-point values, take a look at `java.math.BigDecimal`. Interestingly, `BigDecimal` objects represent floating-point numbers internally using a `BigInteger`!

9.8 Incremental Design

One challenge of programming, especially for beginners, is figuring out how to divide a program into methods. In this section, we present a **design process** that allows you to divide a program into methods as you go along. The process is called “encapsulation and generalization”. The essential steps are:

1. Write a few lines of code in `main` or another method, and test them.
2. When they are working, wrap them in a new method, and test again.
3. If it’s appropriate, replace literal values with variables and parameters.

To demonstrate this process, we’ll develop methods that display multiplication tables. We begin by writing and testing a few lines of code. Here is a loop that displays the multiples of two, all on one line:

```
for (int i = 1; i <= 6; i++) {  
    System.out.printf("%4d", 2 * i);  
}  
System.out.println();
```

Each time through the loop, we display the value of `2 * i`, padded with spaces so it’s four characters wide. Since we use `System.out.printf`, the output appears on a single line.

After the loop, we call `println` to print a newline character. Remember that in some environments, none of the output is displayed until the line is complete. The output of the code so far is:

```
2  4  6  8 10 12
```

The next step is **encapsulation**; that is, we “wrap” the code in a method:

```
public static void printRow() {
    for (int i = 1; i <= 6; i++) {
        System.out.printf("%4d", 2 * i);
    }
    System.out.println();
}
```

Finally, we generalize the method to print multiples of other numbers by replacing the constant value 2 with a parameter `n`. This step is called **generalization**, because it makes the method more general (less specific).

```
public static void printRow(int n) {
    for (int i = 1; i <= 6; i++) {
        System.out.printf("%4d", n * i); // generalized n
    }
    System.out.println();
}
```

Invoking this method with the argument 2 yields the same output as before. With the argument 3, the output is:

```
3  6  9 12 15 18
```

By now you can probably guess how we are going to display a multiplication table: we’ll invoke `printRow` repeatedly with different arguments. In fact, we’ll use another loop to iterate through the rows.

```
for (int i = 1; i <= 6; i++) {
    printRow(i);
}
```

And the output looks like this:

```
1  2  3  4  5  6
2  4  6  8 10 12
3  6  9 12 15 18
4  8 12 16 20 24
5 10 15 20 25 30
6 12 18 24 30 36
```

9.9 More Generalization

The previous result is similar to the “nested loops” approach in Section 6.4. However, the inner loop is now encapsulated in the `printRow` method. We can encapsulate the outer loop in a method too:

```
public static void printTable() {
    for (int i = 1; i <= 6; i++) {
        printRow(i);
    }
}
```

The initial version of `printTable` always displays six rows. We can generalize it by replacing the literal 6 with a parameter:

```
public static void printTable(int rows) {
    for (int i = 1; i <= rows; i++) {    // generalized rows
        printRow(i);
    }
}
```

Here is the output of `printTable(7)`:

```
1  2  3  4  5  6
2  4  6  8 10 12
3  6  9 12 15 18
4  8 12 16 20 24
5 10 15 20 25 30
6 12 18 24 30 36
7 14 21 28 35 42
```

That’s better, but it always displays the same number of columns. We can generalize more by adding a parameter to `printRow`:

```
public static void printRow(int n, int cols) {
    for (int i = 1; i <= cols; i++) {    // generalized cols
        System.out.printf("%4d", n * i);
    }
    System.out.println();
}
```

Now `printRow` takes two parameters: `n` is the value whose multiples should be displayed, and `cols` is the number of columns. Since we added a parameter to `printRow`, we also have to change the line in `printTable` where it is invoked:

```
public static void printTable(int rows) {
    for (int i = 1; i <= rows; i++) {
        printRow(i, rows);
    }
}
```

When this line executes, it evaluates `rows` and passes the value, which is 7 in this example, as an argument. In `printRow`, this value is assigned to `cols`. As a result, the number of columns equals the number of rows, so we get a square 7x7 table, instead of the previous 7x6 table.

When you generalize a method appropriately, you often find that it has capabilities you did not plan. For example, you might notice that the multiplication table is symmetric. Since $ab = ba$, all the entries in the table appear twice. You could save ink by printing half of the table, and you would only have to change *one line* of `printTable`:

```
printRow(i, i); // using i for both n and cols
```

This means the length of each row is the same as its row number. The result is a triangular multiplication table.

```
1
2  4
3  6  9
4  8 12 16
5 10 15 20 25
6 12 18 24 30 36
7 14 21 28 35 42 49
```

Generalization makes code more versatile, more likely to be reused, and sometimes easier to write.

9.10 Vocabulary

object-oriented: A way of organizing code and data into objects, rather than independent methods.

object: A collection of related data that comes with a set of methods that operate on the data.

primitive: A data type that stores a single value and provides no methods.

immutable: An object that, once created, cannot be modified. Strings are immutable by design.

wrapper class: Classes in `java.lang` that provide constants and methods for working with primitive types.

parse: To read a string and interpret or translate it.

empty array: An array with no elements and a length of zero.

design process: A process for determining what methods a class or program should have.

encapsulate: To wrap data inside of an object, or to wrap statements inside of a method.

generalize: To replace something unnecessarily specific (like a constant value) with something appropriately general (like a variable or parameter).

9.11 Exercises

The code for this chapter is in the `ch09` directory of `ThinkJavaCode2`. See page xix for instructions on how to download the repository. Before you start the exercises, we recommend that you compile and run the examples.

Exercise 9.1 The point of this exercise is to explore Java types and fill in some of the details that aren't covered in the chapter.

1. Create a new program named `Test.java` and write a `main` method that contains expressions that combine various types using the `+` operator. For example, what happens when you “add” a `String` and a `char`? Does it perform character addition or string concatenation? What is the type of the result? (How can you determine the type of the result?)

2. Make a bigger copy of the following table and fill it in. At the intersection of each pair of types, you should indicate whether it is legal to use the `+` operator with these types, what operation is performed (addition or concatenation), and what the type of the result is.

	boolean	char	int	double	String
boolean					
char					
int					
double					
String					

3. Think about some of the choices the designers of Java made, based on this table. How many of the entries seem unavoidable, as if there was no other choice? How many seem like arbitrary choices from several equally reasonable possibilities? Which entries seem most problematic?
4. Here's a puzzler: normally, the statement `x++` is exactly equivalent to `x = x + 1`. But if `x` is a `char`, it's not exactly the same! In that case, `x++` is legal, but `x = x + 1` causes an error. Try it out and see what the error message is, then see if you can figure out what is going on.
5. What happens when you add `""` (the empty string) to the other types, for example, `"" + 5`?

Exercise 9.2 You might be sick of the factorial method by now, but we're going to do one more version.

1. Create a new program called `Big.java` and write an iterative version of `factorial` (using a `for` loop).
2. Display a table of the integers from 0 to 30 along with their factorials. At some point around 15, you will probably see that the answers are not correct anymore. Why not?
3. Convert `factorial` so that it performs its calculation using `BigInteger`s and returns a `BigInteger` as a result. You can leave the parameter alone; it will still be an integer.

4. Try displaying the table again with your modified factorial method. Is it correct up to 30? How high can you make it go?

Exercise 9.3 Many encryption algorithms depend on the ability to raise large integers to a power. Here is a method that implements an efficient algorithm for integer exponentiation:

```
public static int pow(int x, int n) {
    if (n == 0) return 1;

    // find x to the n/2 recursively
    int t = pow(x, n / 2);

    // if n is even, the result is t squared
    // if n is odd, the result is t squared times x
    if (n % 2 == 0) {
        return t * t;
    } else {
        return t * t * x;
    }
}
```

The problem with this method is that it only works if the result is small enough to be represented by an `int`. Rewrite it so that the result is a `BigInteger`. The parameters should still be integers, though.

You should use the `BigInteger` methods `add` and `multiply`. But don't use `BigInteger.pow`; that would spoil the fun.

Exercise 9.4 One way to calculate e^x is to use the following infinite series expansion. The i th term in the series is $x^i/i!$.

$$e^x = 1 + x + x^2/2! + x^3/3! + x^4/4! + \dots$$

1. Write a method called `myexp` that takes `x` and `n` as parameters and estimates e^x by adding the first `n` terms of this series. You can use the `factorial` method from Section 8.3 or your iterative version from the previous exercise.

2. You can make this method more efficient by observing that the numerator of each term is the same as its predecessor multiplied by `x`, and the denominator is the same as its predecessor multiplied by `i`.

Use this observation to eliminate the use of `Math.pow` and `factorial`, and check that you get the same result.

3. Write a method called `check` that takes a parameter, `x`, and displays `x`, `myexp(x)`, and `Math.exp(x)`. The output should look something like:

```
1.0      2.708333333333333      2.718281828459045
```

You can use the escape sequence `"\t"` to put a tab character between columns of a table.

4. Vary the number of terms in the series (the second argument that `check` sends to `myexp`) and see the effect on the accuracy of the result. Adjust this value until the estimated value agrees with the correct answer when `x` is 1.
5. Write a loop in `main` that invokes `check` with the values 0.1, 1.0, 10.0, and 100.0. How does the accuracy of the result vary as `x` varies? Compare the number of digits of agreement rather than the difference between the actual and estimated values.
6. Add a loop in `main` that checks `myexp` with the values -0.1, -1.0, -10.0, and -100.0. Comment on the accuracy.

Exercise 9.5 The goal of this exercise is to practice encapsulation and generalization using some of the examples in previous chapters.

1. Starting with the code in Section 7.5, write a method called `powArray` that takes a `double` array, `a`, and returns a new array that contains the elements of `a` squared. Generalize it to take a second argument and raise the elements of `a` to the given power.
2. Starting with the code in Section 7.8, write a method called `histogram` that takes an `int` array of scores from 0 to (but not including) 100, and returns a histogram of 100 counters. Generalize it to take the number of counters as an argument.

Exercise 9.6 The following code fragment traverses a string and checks whether it has the same number of open and close parentheses:

```
String s = "((3 + 7) * 2)";
int count = 0;

for (int i = 0; i < s.length(); i++) {
    char c = s.charAt(i);
    if (c == '(') {
        count++;
    } else if (c == ')') {
        count--;
    }
}

System.out.println(count);
```

1. Encapsulate this fragment in a method that takes a string argument and returns the final value of `count`.
2. Test your method with multiple strings, including some that are balanced and some that are not.
3. Generalize the code so that it works on any string. What could you do to generalize it more?

Chapter 10

Mutable Objects

As you learned in the previous chapter, an object is a collection of data that provides a set of methods. For example, a `String` is a collection of characters that provides methods like `charAt` and `substring`.

In this chapter, we'll explore two new types of objects: `Point` and `Rectangle`. We'll see how to write methods that take objects as parameters and produce objects as return values.

We will also take a first look at the source code for the Java library.

10.1 Point Objects

In math, 2D “points” are often written in parentheses with a comma separating the coordinates. For example, $(0, 0)$ indicates the origin, and (x, y) indicates the point x units to the right and y units up from the origin.

The `java.awt` package provides a class named `Point` that represents a location in a Cartesian plane. In order to use the `Point` class, you have to import it:

```
import java.awt.Point;
```

Then, to create a new point, you use the `new` operator:

```
Point blank;  
blank = new Point(3, 4);
```

The first line declares that `blank` has type `Point`. The second line creates the new `Point` with the coordinates $x = 3$ and $y = 4$. The result of the `new` operator is a *reference* to the object. Figure 10.1 shows the result.

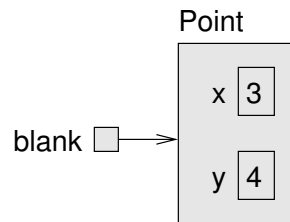

Figure 10.1: Memory diagram showing a variable that refers to a `Point` object.

As usual, the name of the variable `blank` appears outside the box, and its value appears inside the box. In this case, the value is a reference, which is represented with an arrow. The arrow points to the `Point` object, which contains two variables, `x` and `y`.

Variables that belong to an object are called **attributes**. In some documentation, you also see them called “fields”. To access an attribute of an object, Java uses **dot notation**. For example:

```
int x = blank.x;
```

The expression `blank.x` means “go to the object `blank` refers to, and get the value of the attribute `x`.” In this case, we assign that value to a local variable named `x`.

There is no conflict between the local variable `x` and the attribute `x`. The purpose of dot notation is to identify *which* variable you are referring to unambiguously.

You can use dot notation as part of an expression. For example:

```
System.out.println(blank.x + ", " + blank.y);  
int sum = blank.x * blank.x + blank.y * blank.y;
```

The first line displays 3, 4. The second line calculates the value 25.

10.2 Objects as Parameters

You can pass objects as parameters in the usual way. For example:

```
public static void printPoint(Point p) {
    System.out.println("(" + p.x + ", " + p.y + ")");
}
```

This method takes a point as an argument and displays its attributes in parentheses. If you invoke `printPoint(blank)`, it displays (3, 4).

As another example, we can rewrite the `distance` method from Section 4.9 so that it takes two `Points` as parameters instead of four `doubles`.

```
public static double distance(Point p1, Point p2) {
    int dx = p2.x - p1.x;
    int dy = p2.y - p1.y;
    return Math.sqrt(dx * dx + dy * dy);
}
```

Passing objects as parameters makes the source code more readable and less error-prone because related values are bundled together.

You actually don't need to write a `distance` method, because `Point` objects have one built-in already. To compute the distance between two points, we invoke `distance` on one and pass the other as an argument.

```
Point p1 = new Point(0, 0);
Point p2 = new Point(3, 4);
double dist = p1.distance(p2); // dist is 5.0
```

It turns out you don't need the `printPoint` method either. If you invoke `System.out.println(blank)` you get even more information:

```
java.awt.Point[x=3,y=4]
```

`Point` objects provide a method called `toString` that returns a string representation of a point. When you call `println` with objects, it *automatically* calls `toString` and displays the result. In this case, it shows the name of the type (`java.awt.Point`) and the names and values of the attributes.

10.3 Objects as Return Values

The `java.awt` package also provides a class named `Rectangle`. To use it, you have to import it:

```
import java.awt.Rectangle;
```

`Rectangle` objects are similar to points, but they have four attributes: `x`, `y`, `width`, and `height`. The following example creates a `Rectangle` object and makes the variable `box` refer to it:

```
Rectangle box = new Rectangle(0, 0, 100, 200);
```

Figure 10.2 shows the effect of this assignment.

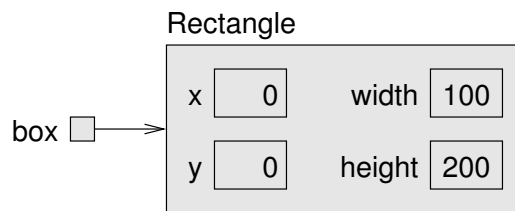

Figure 10.2: Memory diagram showing a `Rectangle` object.

If you run `System.out.println(box)`, you get:

```
java.awt.Rectangle[x=0,y=0,width=100,height=200]
```

Again, `println` uses the `toString` method provided by `Rectangle`, which knows how to represent `Rectangle` objects as strings.

You can write methods that return new objects. For example, `findCenter` takes a `Rectangle` as an argument and returns a `Point` with the coordinates of the center of the rectangle:

```
public static Point findCenter(Rectangle box) {  
    int x = box.x + box.width / 2;  
    int y = box.y + box.height / 2;  
    return new Point(x, y);  
}
```

The return type of this method is `Point`. The last line creates a new `Point` object and returns a reference to it.

10.4 Rectangles are Mutable

You can change the contents of an object by making an assignment to one of its attributes. For example, to “move” a rectangle without changing its size, you can modify the `x` and `y` values:

```
Rectangle box = new Rectangle(0, 0, 100, 200);
box.x = box.x + 50;
box.y = box.y + 100;
```

The result is shown in Figure 10.3.

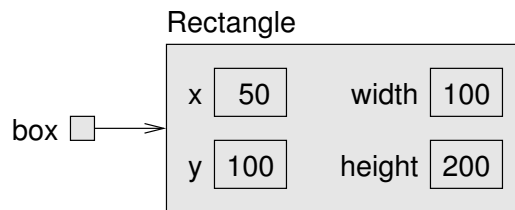

Figure 10.3: Memory diagram showing updated attributes.

We can encapsulate this code in a method and generalize it to move the rectangle by any amount:

```
public static void moveRect(Rectangle box, int dx, int dy) {
    box.x = box.x + dx;
    box.y = box.y + dy;
}
```

The variables `dx` and `dy` indicate how far to move the rectangle in each direction. Invoking this method has the effect of modifying the `Rectangle` that is passed as an argument.

```
Rectangle box = new Rectangle(0, 0, 100, 200);
moveRect(box, 50, 100); // now at (50, 100, 100, 200)
```

Modifying objects by passing them as arguments to methods can be useful. But it can also make debugging more difficult, because it is not always clear which method invocations modify their arguments.

Java provides a number of methods that operate on `Points` and `Rectangles`. For example, `translate` has the same effect as `moveRect`, but instead of passing the rectangle as an argument, you use dot notation:

```
box.translate(50, 100);
```

This line invokes the `translate` method for the object that `box` refers to. This method modifies the `box` object it is invoked on.

This style, using dot notation to invoke a method on an object, rather than passing it as a parameter, is more consistent with the style of object-oriented programming.

10.5 Aliasing Revisited

Remember that when you assign an object to a variable, you are assigning a *reference* to an object. It is possible to have multiple variables that refer to the same object. For example, this code creates two variables that refer to the same `Rectangle`:

```
Rectangle box1 = new Rectangle(0, 0, 100, 200);  
Rectangle box2 = box1;
```

Figure 10.4 shows the result: `box1` and `box2` refer to the same object, so any changes that affect one variable also affect the other.

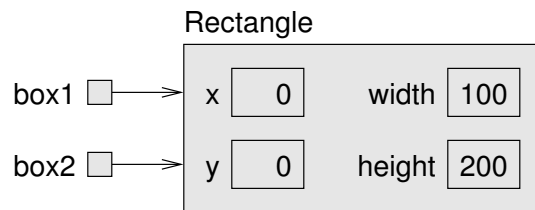

Figure 10.4: Memory diagram showing two variables that refer to the same `Rectangle` object.

For example, the following code uses `grow` to make `box1` bigger by 50 units in all directions. It decreases `x` and `y` by 50, and increases `height` and `width` by 100:

```
box1.grow(50, 50); // grow box1 (alias)
```

The result is shown in Figure 10.5.

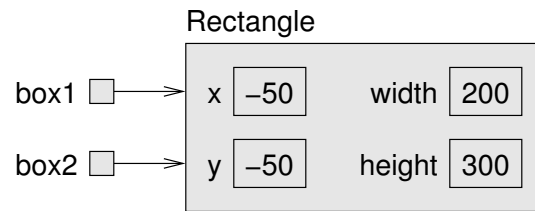

Figure 10.5: Memory diagram showing the effect of invoking `grow`.

Now, if we print `box1`, we are not surprised to see that it has changed.

```
java.awt.Rectangle[x=-50,y=-50,width=200,height=300]
```

And if we print `box2`, we should not be surprised to see that it has changed, too, because it refers to the same object:

```
java.awt.Rectangle[x=-50,y=-50,width=200,height=300]
```

This scenario is called “aliasing” because a single object has multiple names, or aliases, that refer to it.

As you can tell from this simple example, code that involves aliasing can get confusing fast, and it can be difficult to debug.

10.6 Java Library Source

So far you have used classes from the Java library including `System`, `String`, `Scanner`, `Math`, `Random`, and others. These classes are written in Java, so you can read the source code to see how they work.

The Java library contains thousands of files, many of which are thousands of lines of code. That’s more than one person could read and understand fully, but don’t be intimidated!

Because it’s so large, the library source code is stored in a ZIP archive named `src.zip`. If you have Java installed on your computer, you should already have this file somewhere.

- On Linux, it’s likely under: `/usr/lib/jvm`
If not, you might have to install the `openjdk-...-source` package.

- On MacOS, it's likely under:
/Library/Java/JavaVirtualMachines/jdk.../Contents/Home/
- On Windows, it's likely under: C:\Program Files\Java\jdk...\

When you open (or unzip) the file, you will see folders that correspond to Java packages. For example, open the `java` folder, and then open the `awt` folder. (If you don't see a `java` folder at first, open the `java.desktop` folder.) You should now see `Point.java` and `Rectangle.java`, along with the other classes in the `java.awt` package.

Open `Point.java` in your editor and skim through the file. It uses language features we haven't discussed yet, so you probably won't understand every line. But you can get a sense of what professional Java source code looks like by browsing through the library.

Notice how much of `Point.java` is documentation (see Appendix B). Each method is thoroughly commented, including `@param`, `@return`, and other tags. Javadoc reads these comments and generates documentation in HTML. You can see the same documentation online by doing a web search for "Java Point".

Now take a look at the `Rectangle` class's `grow` and `translate` methods. There is more to them than you may have expected.

10.7 Class Diagrams

To summarize what we've learned so far, `Point` and `Rectangle` objects have their own attributes and methods. Attributes are an object's *data*, and methods are an object's *code*. An object's *class* defines the attributes and methods that it has.

Unified Modeling Language (UML) defines a graphical way to summarize this information about a class. Figure 10.6, shows two examples, the **UML class diagrams** for the `Point` and `Rectangle` classes.

Each class is represented by a box with the name of the class, a list of the attributes, and a list of methods.

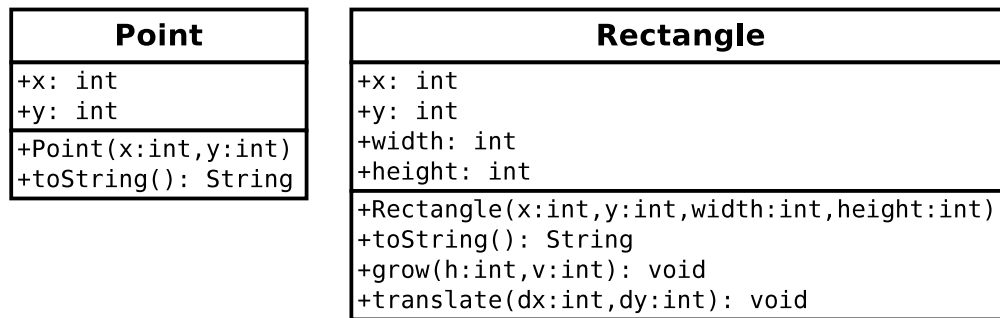

Figure 10.6: UML class diagrams for `Point` and `Rectangle`.

To identify the types of attributes and parameters, UML uses a language-independent syntax, like `x: int` rather than Java syntax, `int x`.

The plus sign (+) identifies `public` attributes and methods. A minus sign (-) would identify `private` attributes and methods, which we discuss in the next chapter.

Both `Point` and `Rectangle` have additional methods; we are only showing the ones introduced in this chapter.

In contrast to memory diagrams, which visualize objects (and variables) at run-time, a class diagram visualizes the source code at compile-time.

10.8 Scope Revisited

In Section 4.5, we introduced the idea that variables have scope. The scope of a variable is the area of a program where a variable can be used.

Consider the first few lines of the `Rectangle.translate` method from the Java library source code:

```
public void translate(int dx, int dy) {
    int oldv = this.x;
    int newv = oldv + dx;
    if (dx < 0) {
        ...
    }
}
```

This example uses three kinds of variables:

1. Parameters (`dx` and `dy`)
2. Local variables (`oldv` and `newv`)
3. Attributes (`this.x`)

Parameters and local variables are created when a method is invoked, and they disappear when the method returns. They can be used anywhere inside the method, but not in other methods and not in other classes.

When the Java compiler encounters a variable name, it searches backwards for its declaration. The compiler first looks for local variables, then parameters, then attributes.

Attributes are created when an object is created, and they disappear when the object is destroyed. They can be used in any of the object's methods via the keyword `this`. And they can be used in other classes via references to the object (e.g., `box1.x`).

10.9 Garbage Collection

In the previous section, we said that attributes exist as long as the object exists. But when does an object cease to exist? Here is a simple example:

```
Point blank = new Point(3, 4);  
blank = null;
```

The first line creates a new `Point` object and makes `blank` refer to it. The second line changes `blank` so that instead of referring to the object, it refers to nothing. As shown in Figure 10.7, there is no longer an arrow between them.

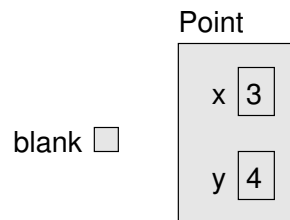

Figure 10.7: Memory diagram showing the effect of setting a variable to `null`.

If there are no references to an object, there is no way to access its attributes or invoke a method on it. From the program's point of view, it ceases to exist. However, it's still present in the computer's memory, taking up space.

As your program runs, the system automatically looks for stranded objects and deletes them; then the space can be reused for new objects. This process is called **garbage collection**.

You don't have to do anything to make garbage collection happen, and in general, you don't have to be aware of it. But in high-performance applications, you may notice a slight delay every now and then when Java reclaims space from discarded objects.

10.10 Mutable vs Immutable

`Points` and `Rectangles` are **mutable** objects, because their attributes can be modified. You can modify their attributes directly, like `box.x = 15`, or you can invoke methods that modify their attributes, like `box.translate(15, 0)`.

In contrast, immutable objects like `Strings` and `Integers` cannot be modified. They don't allow direct access to their attributes or provide methods that change them.

Immutable objects have a number of advantages that help improve the performance and reliability of programs. For example, two strings that contain the same contents can be stored in memory only once. The Java compiler automatically detects this situation:

```
public class Surprise {
    public static void main(String[] args) {
        String s1 = "Hi, Mom!";
        String s2 = "Hi, " + "Mom!";
        if (s1 == s2) { // true!
            System.out.println("s1 and s2 are the same");
        }
    }
}
```

In this example, `s1` and `s2` refer to the *same* string, even though they are created differently. Because strings are immutable, the compiler decides to use a single object for both `s1` and `s2`. As a result, `s1 == s2`, even though it appears they might be different objects.

Since neither variable can change the string itself, both `s1` and `s2` will be `"Hi, Mom!"` until they are reassigned. You can pass strings (and other immutable objects) to methods without worrying about their contents changing as a “side-effect” of the method.

On the other hand, mutable objects have their own advantages. It’s more efficient to move a rectangle by changing its coordinates than to create a new `Rectangle` each time.

And as we’ll see later, it’s easier to implement objects that allow their attributes to be changed.

10.11 StringBuilder Objects

Strings are particularly inefficient when you need to concatenate them multiple times. Consider the following program that inputs ten lines from `System.in` and concatenates them into a single `String`.

```
import java.util.Scanner;
public class Append {
    public static void main(String[] args) {
        Scanner in = new Scanner(System.in);
        System.out.println("Enter 10 lines:");
        String text = "";
        for (int i = 0; i < 10; i++) {
            String line = in.nextLine();           // new string
            text = text + line + '\n';           // two more strings
        }
        System.out.print("You entered:\n" + text);
    }
}
```

Inside the `for` loop, `in.nextLine()` returns a new string each time it is invoked. The next line of code concatenates `text` and `line`, which creates

another string, and then appends the newline character, which creates yet another string.

As a result, this loop creates 30 `String` objects! At the end, `text` refers to the most recent `String`. Garbage collection deletes the rest, but that's a lot of garbage for a seemingly simple program.

The Java library provides the `StringBuilder` class for just this reason. It's part of the `java.lang` package, so you don't need to import it. Because `StringBuilder` objects are mutable, they can implement concatenation more efficiently.

Here's a version of the program that uses `StringBuilder`:

```
StringBuilder text = new StringBuilder();
for (int i = 0; i < 10; i++) {
    String line = in.nextLine();
    text.append(line);
    text.append('\n');
}
```

The `append` method takes a `String` as a parameter and appends it to the end of the `StringBuilder`. Each time it is invoked, it modifies the `StringBuilder`; it doesn't create any new objects.

The `StringBuilder` class also provides methods for inserting and deleting parts of strings efficiently. Programs that manipulate large amounts of text run much faster if you use `StringBuilder` objects instead of `Strings`.

10.12 Vocabulary

attribute: One of the named data items that make up an object.

dot notation: Use of the dot operator (`.`) to access an object's attributes or methods.

UML: Unified Modeling Language, a standard way to draw diagrams for software engineering.

class diagram: An illustration of the attributes and methods for a class.

garbage collection: The process of finding objects that have no references and reclaiming their storage space.

mutable: An object that can be modified at any time. Points and rectangles are mutable by design.

10.13 Exercises

The code for this chapter is in the `ch10` directory of `ThinkJavaCode2`. See page xix for instructions on how to download the repository. Before you start the exercises, we recommend that you compile and run the examples.

At this point you know enough to read Appendix C, which is about simple 2D graphics and animations. During the next few chapters, you should take a detour to read this appendix and work through the exercises.

Exercise 10.1 The point of this exercise is to make sure you understand the mechanism for passing objects as parameters.

1. For the following program, draw a stack diagram showing the local variables and parameters of `main` and `riddle` just before `riddle` returns. Use arrows to show which objects each variable references.
2. What is the output of the program?
3. Is the `blank` object mutable or immutable? How can you tell?

```
public static int riddle(int x, Point p) {
    x = x + 7;
    return x + p.x + p.y;
}
```

```
public static void main(String[] args) {
    int x = 5;
    Point blank = new Point(1, 2);

    System.out.println(riddle(x, blank));
    System.out.println(x);
    System.out.println(blank.x);
    System.out.println(blank.y);
}
```

Exercise 10.2 The point of this exercise is to make sure you understand the mechanism for returning new objects from methods. The following code uses `findCenter` and `distance` as defined in this chapter.

1. Draw a stack diagram showing the state of the program just before `findCenter` returns. Include all variables and parameters, and show the objects those variables refer to.
2. Draw a stack diagram showing the state of the program just before `distance` returns. Show all variables, parameters, and objects.
3. What is the output of this program? (Can you tell without running it?)

```
public static void main(String[] args) {
    Point blank = new Point(5, 8);

    Rectangle rect = new Rectangle(0, 2, 4, 4);
    Point center = findCenter(rect);

    double dist = distance(center, blank);
    System.out.println(dist);
}
```

Exercise 10.3 This exercise is about aliasing. Recall that aliases are two variables that refer to the same object. The following code uses `findCenter` and `printPoint` as defined in this chapter.

1. Draw a diagram that shows the state of the program just before the end of `main`. Include all local variables and the objects they refer to.
2. What is the output of the program?
3. At the end of `main`, are `p1` and `p2` aliased? Why or why not?

```
public static void main(String[] args) {
    Rectangle box1 = new Rectangle(2, 4, 7, 9);
    Point p1 = findCenter(box1);
    printPoint(p1);

    box1.grow(1, 1);
    Point p2 = findCenter(box1);
    printPoint(p2);
}
```

Chapter 11

Designing Classes

Whenever you create a new class, you are creating a new object type with the same name. So way back in Section 1.3, when we created the class `Hello`, we also created an object type named `Hello`.

We didn't declare any variables with type `Hello`, and we didn't use `new` to create `Hello` objects. And it wouldn't have done much good if we had – but we could have!

In this chapter, you will learn to design classes that represent *useful* objects. Here are the main ideas:

- Again, defining a **class** creates a new object type with the same name.
- A class definition is a template for objects: it specifies what attributes the objects have and what methods can operate on them.
- Every object belongs to some object type; that is, it is an **instance** of some class.
- The `new` operator **instantiates** objects; that is, it creates new instances of a class.
- The methods that operate on an object type are defined in the class for that object.

Think of a class like a blueprint for a house: you can use the same blueprint to build any number of houses.

11.1 The Time Class

A common reason to define a new class is to encapsulate related data in an object that can be treated as a single unit. That way, we can use objects as parameters and return values, rather than passing and returning multiple values. We have already seen two types that encapsulate data in this way: `Point` and `Rectangle`.

Another example, which we will implement ourselves, is `Time`, which represents a time of day. The data encapsulated in a `Time` object include an hour, a minute, and a number of seconds. Because every `Time` object contains these values, we define attributes to hold them.

Attributes are also called **instance variables**, because each instance has its own variables (as opposed to “class variables”, coming up in Section 12.3).

The first step is to decide what type each variable should be. It seems clear that `hour` and `minute` should be integers. Just to keep things interesting, let’s make `second` a double.

Instance variables are declared at the beginning of the class definition, outside of any method. By itself, this code fragment is a legal class definition:

```
public class Time {
    private int hour;
    private int minute;
    private double second;
}
```

The `Time` class is `public`, which means that it can be used in other classes. But the instance variables are `private`, which means they can only be accessed from inside the `Time` class. If you try to read or write them from another class, you will get a compiler error.

Private instance variables help keep classes isolated from each other, so that changes in one class won’t require changes in other classes. It also simplifies what other programmers need to know to use your classes. This kind of isolation is called **information hiding**.

11.2 Constructors

After declaring instance variables, the next step is to define a **constructor**, which is a special method that initializes the object. The syntax for constructors is similar to that of other methods, except:

- The name of the constructor is the same as the name of the class.
- Constructors have no return type (and no return value).
- The keyword `static` is omitted.

Here is an example constructor for the `Time` class:

```
public Time() {  
    this.hour = 0;  
    this.minute = 0;  
    this.second = 0.0;  
}
```

This constructor does not take any arguments. Each line initializes an instance variable to zero (which is “midnight” for a `Time` object).

The name `this` is a keyword that refers to the object we are creating. You can use `this` the same way you use the name of any other object. For example, you can read and write the instance variables of `this`, and you can pass `this` as an argument to other methods. But you do not declare `this`, and you can’t make an assignment to it.

A common error when writing constructors is to put a `return` statement at the end. Like `void` methods, constructors do not return values.

To create a `Time` object, you must use the `new` operator:

```
public static void main(String[] args) {  
    Time time = new Time();  
}
```

When you use `new`, Java creates the object and invokes your constructor to initialize the instance variables. When the constructor is done, `new` returns a

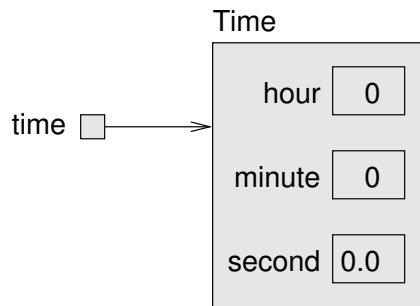

Figure 11.1: Memory diagram of a `Time` object.

reference to the new object. In this example, the reference gets assigned to the variable `time`, which has type `Time`. Figure 11.1 shows the result.

Beginners sometimes make the mistake of using `new` in the constructor:

```
public Time() {  
    new Time();           // StackOverflowError  
    this.hour = 0;  
    this.minute = 0;  
    this.second = 0.0;  
}
```

Doing so causes an infinite recursion, since `new` invokes the *same* constructor, which uses `new` again, which invokes the constructor again, and so on.

11.3 More Constructors

Like other methods, constructors can be overloaded, which means you can provide multiple constructors with different parameters. Java knows which constructor to invoke by matching the arguments you provide with the parameters of the constructor.

It is common to provide both a “default constructor” that takes no arguments, like the previous one, and a “value constructor”, like this one:

```
public Time(int hour, int minute, double second) {
    this.hour = hour;
    this.minute = minute;
    this.second = second;
}
```

To invoke this constructor, you have to provide arguments to the `new` operator. The following example creates a `Time` object that represents a fraction of a second before noon:

```
Time time = new Time(11, 59, 59.9);
```

Overloading constructors provides the flexibility to create an object first and then fill in the attributes, or collect all the information before creating the object itself.

Once you get the hang of it, writing constructors gets boring. You can write them quickly just by looking at the list of instance variables. In fact, some IDEs can generate them for you.

Here is the complete class definition so far:

```
public class Time {
    private int hour;
    private int minute;
    private double second;

    public Time() {
        this.hour = 0;
        this.minute = 0;
        this.second = 0.0;
    }

    public Time(int hour, int minute, double second) {
        this.hour = hour;
        this.minute = minute;
        this.second = second;
    }
}
```

Notice how the second constructor declares the parameters `hour`, `minute`, and `second`. Java allows you to declare parameters (and local variables) with the same names as instance variables. They don't have to use the same names, but it's common practice.

The right side of `this.hour = hour;` refers to the parameter `hour`, since it was declared most recently. This situation is called **shadowing**, because the parameter “hides” the instance variable with the same name.

Java provides the keyword `this` so you can access instance variables, regardless of shadowing. As a result, this constructor copies the values from the parameters to the instance variables.

11.4 Getters and Setters

Recall that the instance variables of `Time` are `private`. We can access them from within the `Time` class, but if we try to read or write them from another class, the compiler reports an error.

A class that uses objects defined in another class is called a **client**. For example, here is a new class called `TimeClient`.

```
public class TimeClient {  
  
    public static void main(String[] args) {  
        Time time = new Time(11, 59, 59.9);  
        System.out.println(time.hour);    // compiler error  
    }  
}
```

If you compile this code, you get an error message like “hour has private access in Time”. There are three ways to solve this problem:

- We could make the instance variables public.
- We could provide methods to access the instance variables.
- We could decide that it's not a problem, and refuse to let other classes access the instance variables.

The first choice is appealing because it's simple. But here is the problem: when Class *A* accesses the instance variables of Class *B* directly, *A* becomes dependent on *B*. If anything in *B* changes later, it is likely that *A* will have to change, too.

But if *A* only uses methods to interact with *B*, *A* and *B* are less dependent, which means that we can make changes in *B* without affecting *A* (as long as we don't change the method parameters). So we generally avoid making instance variables public.

The second option is to provide methods that access the instance variables. For example, we might want the instance variables to be “read only”; that is, code in other classes should be able to read them but not write them. We can do that by providing one method for each instance variable:

```
public int getHour() {
    return this.hour;
}

public int getMinute() {
    return this.minute;
}

public double getSecond() {
    return this.second;
}
```

Methods like these are formally called “accessors”, but more commonly referred to as **getters**. By convention, the method that gets a variable named *something* is called `getSomething`.

We can fix the compiler error in `TimeClient` by using the getter:

```
System.out.println(time.getHour());
```

If we decide that `TimeClient` should also be able to modify the instance variables of `Time`, we can provide methods to do that, too:

```
public void setHour(int hour) {
    this.hour = hour;
}

public void setMinute(int minute) {
    this.minute = minute;
}

public void setSecond(double second) {
    this.second = second;
}
```

These methods are formally called “mutators”, but more commonly known as **setters**. The naming convention is similar; the method that sets something is usually called `setSomething`.

Writing getters and setters can get boring, but many IDEs can generate them for you based on the instance variables.

11.5 Displaying Objects

To display `Time` objects we can write a method to display the hour, minute, and second. Using `printTime` in Section 4.4 as a starting point, we could write:

```
public static void printTime(Time t) {
    System.out.print(t.hour);
    System.out.print(":");
    System.out.print(t.minute);
    System.out.print(":");
    System.out.println(t.second);
}
```

The output of this method, given the `time` object from the first example, would be `11:59:59.9`. We can use `printf` to make the code more concise:

```
public static void printTime(Time t) {
    System.out.printf("%02d:%02d:%04.1f\n",
        t.hour, t.minute, t.second);
}
```

As a reminder, you need to use `%d` with integers and `%f` with floating-point numbers. The `02` option means “total width 2, with leading zeros if necessary”, and the `04.1` option means “total width 4, one digit after the decimal point, leading zeros if necessary”. The output is the same: `11:59:59.9`.

There’s nothing wrong with a method like `printTime`, but it is not consistent with object-oriented style. A more idiomatic solution is to provide a special method called `toString`.

11.6 The toString Method

Every object has a method called `toString` that returns a string representation of the object. When you display an object using `print` or `println`, Java invokes the object’s `toString` method.

By default it simply displays the type of the object and its address in hexadecimal. So, if you create a `Time` object and display it with `println`:

```
public static void main(String[] args) {
    Time time = new Time(11, 59, 59.9);
    System.out.println(time);
}
```

The output looks something like this:

```
Time@80cc7c0
```

This address can be useful for debugging, if you want to keep track of individual objects.

But you can **override** this behavior by providing your own `toString` method. For example, here is a `toString` method for `Time`:

```
public String toString() {
    return String.format("%02d:%02d:%04.1f\n",
        this.hour, this.minute, this.second);
}
```

The definition does not have the keyword `static`, because it is not a static method. It is an **instance method**, so called because when you invoke it, you

invoke it on an instance of the class. Instance methods are sometimes called “non-static”; you might see this term in an error message.

The body of the method is similar to `printTime` in the previous section, with two changes:

- Inside the method, we use `this` to refer to the current instance; that is, the object the method is invoked on.
- Instead of `printf`, it uses `String.format`, which returns a formatted `String` rather than displaying it.

Now you can call `toString` directly:

```
Time time = new Time(11, 59, 59.9);
String s = time.toString();
```

The value of `s` is the `String` `"11:59:59.9"`.

You can also invoke `toString` indirectly by invoking `print` or `println`:

```
System.out.println(time);
```

This code displays the `String` `"11:59:59.9"`.

Either way, when you use `this` inside `toString`, it refers to the same object as `time`.

11.7 The equals Method

We have seen two ways to check whether values are equal: the `==` operator and the `equals` method. With objects you can use either one, but they are not the same.

- The `==` operator checks whether two references are **identical**; that is, whether they refer to the same object.
- The `equals` method checks whether two objects are **equivalent**; that is, whether they have the same values.

The definition of identity is always the same, so the `==` operator always does the same thing. But the definition of equivalence is different for different objects, so objects can define their own `equals` methods.

Consider the following variables and the memory diagram in Figure 11.2.

```
Time time1 = new Time(9, 30, 0.0);
Time time2 = time1;
Time time3 = new Time(9, 30, 0.0);
```

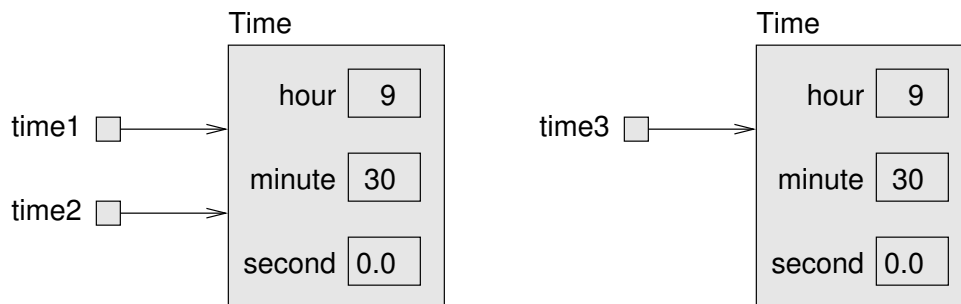

Figure 11.2: Memory diagram of three `Time` variables.

The assignment operator copies references, so `time1` and `time2` refer to the same object. Because they are identical, `time1 == time2` is true. But `time1` and `time3` refer to two different objects. Because they are not identical, `time1 == time3` is false.

By default, the `equals` method does the same thing as `==`. For `Time` objects, that's probably not what we want. For example, `time1` and `time3` represent the same time of day, so we should consider them equivalent.

We can provide an `equals` method that implements this idea:

```
public boolean equals(Time that) {
    final EPS = 0.001;
    return this.hour == that.hour
        && this.minute == that.minute
        && Math.abs(this.second - that.second) < EPS;
}
```

`equals` is an instance method, so it doesn't have the keyword `static`. It uses `this` to refer to current object, and `that` to refer to the other. `that` is *not* a

keyword, so we could have given this parameter a different name. But using `that` makes the code nicely readable.

We can invoke `equals` like this:

```
time1.equals(time3);
```

Inside the `equals` method, `this` refers to the same object as `time1`, and `that` refers to the same object as `time3`. Since their instance variables are “equal”, the result is `true`.

Because `hour` and `minute` are integers, we compare them with `==`. But `second` is a floating-point number. Because of rounding errors, it is not good to compare floating-point numbers with `==` (see Section 2.7). Instead, we check whether the difference is smaller than a threshold, `EPS`.

Many objects have a similar notion of equivalence; that is, two objects are considered equal if their instance variables are equal. But other definitions are possible.

11.8 Adding Times

Suppose you are going to a movie that starts at 18:50 (that is, 6:50 PM), and the running time is 2 hours 16 minutes. What time does the movie end? We’ll use `Time` objects to figure it out.

```
Time startTime = new Time(18, 50, 0.0);  
Time runningTime = new Time(2, 16, 0.0);
```

Here are two ways we could “add” the `Time` objects:

- We could write a static method that takes two `Time` objects as parameters.
- We could write an instance method that gets invoked on one object and takes the other as a parameter.

To demonstrate the difference, we'll do both. Here is the static method:

```
public static Time add(Time t1, Time t2) {
    Time sum = new Time();
    sum.hour = t1.hour + t2.hour;
    sum.minute = t1.minute + t2.minute;
    sum.second = t1.second + t2.second;
    return sum;
}
```

And here's how we would invoke it:

```
Time endTime = Time.add(startTime, runningTime);
```

Here's what it looks like as an instance method:

```
public Time add(Time t2) {
    Time sum = new Time();
    sum.hour = this.hour + t2.hour;
    sum.minute = this.minute + t2.minute;
    sum.second = this.second + t2.second;
    return sum;
}
```

And here's how we would invoke it:

```
Time endTime = startTime.add(runningTime);
```

Notice the differences:

- The static method has the keyword `static`; the instance method does not.
- The static method has two parameters, `t1` and `t2`. The instance method has one explicit parameter, `t1`, and the implicit parameter, `this`.
- We invoked the static method with the `Time` class; we invoked the instance method with the `startTime` object.

That's all there is to it. Static methods and instance methods do the same thing, and you can convert from one to the other with just a few changes.

However, there's a problem with both of these methods; they are not correct. The result from either method is 20:66, which is not a valid time.

If `second` exceeds 59, we have to “carry” into the minutes column, and if `minute` exceeds 59, we have to carry into hour.

Here is a better version of the instance method, `add`:

```
public Time add(Time t2) {
    Time sum = new Time();
    sum.hour = this.hour + t2.hour;
    sum.minute = this.minute + t2.minute;
    sum.second = this.second + t2.second;

    if (sum.second >= 60.0) {
        sum.second -= 60.0;
        sum.minute += 1;
    }
    if (sum.minute >= 60) {
        sum.minute -= 60;
        sum.hour += 1;
    }
    return sum;
}
```

It's still possible that `hour` may exceed 23, but there's no `days` attribute to carry into. In that case, `sum.hour -= 24` would yield the correct result.

11.9 Vocabulary

class: Previously, we defined a class as a collection of related methods. Now you know that a class is also a template for a new type of object.

instance: A member of a class. Every object is an instance of some class.

instantiate: Create a new instance of a class in the computer's memory.

instance variable: An attribute of an object; a non-static variable defined at the class level.

information hiding: The practice of making instance variables `private` to limit dependencies between classes.

constructor: A special method that initializes the instance variables of a newly-constructed object.

shadowing: Occurs when a local variable or parameter has the same name as an attribute.

client: A class that uses objects defined in another class.

getter: A method that returns the value of an instance variable.

setter: A method that assigns a value to an instance variable.

override: Replacing a default implementation of a method, such as `toString`.

instance method: A non-static method that has access to `this` and the instance variables.

identical: References to the same object or the same location in memory are identical.

equivalent: Two objects that are “equal” but not necessarily identical, as defined by the `equals` method.

11.10 Exercises

The code for this chapter is in the `ch11` directory of `ThinkJavaCode2`. See page xix for instructions on how to download the repository. Before you start the exercises, we recommend that you compile and run the examples.

Exercise 11.1 Review the documentation of `java.awt.Rectangle`. Which methods are pure? Which are modifiers?

If you review the documentation of `java.lang.String`, you should see that there are no modifiers, because strings are immutable.

Exercise 11.2 The implementation of `increment` in this chapter is not very efficient. Can you rewrite it so it doesn't use any loops?

Hint: Remember the remainder operator. And yes, it works with floating-point values too.

Exercise 11.3 In the board game Scrabble, each tile contains a letter, which is used to spell words in rows and columns, and a score, which is used to determine the value of words.

1. Write a definition for a class named `Tile` that represents Scrabble tiles. The instance variables should include a character named `letter` and an integer named `value`.
2. Write a constructor that takes parameters named `letter` and `value` and initializes the instance variables.
3. Write a method named `printTile` that takes a `Tile` object as a parameter and displays the instance variables in a reader-friendly format.
4. Write a `main` method that creates a `Tile` object with the letter `Z` and the value `10`, and then uses `printTile` to display the state of the object.
5. Implement the `toString` and `equals` methods for a `Tile`.
6. Create getters and setters for each of the attributes.

The point of this exercise is to practice the mechanical part of creating a new class definition.

Exercise 11.4 Write a class definition for `Date`, an object type that contains three integers: `year`, `month`, and `day`. This class should provide two constructors. The first should take no parameters and initialize a default date. The second should take parameters named `year`, `month` and `day`, and use them to initialize the instance variables.

Write a `main` method that creates a new `Date` object named `birthday`. The new object should contain your birth date. You can use either constructor.

Exercise 11.5 A rational number is a number that can be represented as the ratio of two integers. For example, $2/3$ is a rational number, and you can think of 7 as a rational number with an implicit 1 in the denominator.

1. Define a class called `Rational`. A `Rational` object should have two integer instance variables that store the numerator and denominator.
2. Write a constructor that takes no arguments and that sets the numerator to 0 and denominator to 1.
3. Write an instance method called `printRational` that displays a `Rational` in some reasonable format.
4. Write a `main` method that creates a new object with type `Rational`, sets its instance variables to the values of your choice, and displays the object.
5. At this stage, you have a minimal testable program. Test it and, if necessary, debug it.
6. Write a `toString` method for `Rational` and test it using `println`.
7. Write a second constructor that takes two arguments and uses them to initialize the instance variables.
8. Write an instance method called `negate` that reverses the sign of a rational number. This method should be a modifier, so it should be void. Add lines to `main` to test the new method.
9. Write an instance method called `invert` that inverts the number by swapping the numerator and denominator. It should be a modifier. Add lines to `main` to test the new method.
10. Write an instance method called `toDouble` that converts the rational number to a `double` (floating-point number) and returns the result. This method is a pure method; it does not modify the object. As always, test the new method.
11. Write an instance method named `reduce` that reduces a rational number to its lowest terms by finding the greatest common divisor (GCD) of the numerator and denominator and dividing through. This method should be a pure method; it should not modify the instance variables of the object on which it is invoked.

Hint: Finding the GCD only takes a few lines of code. Search the web for “Euclidean algorithm”.

12. Write an instance method called `add` that takes a `Rational` number as an argument, adds it to `this`, and returns a new `Rational` object.

There are several ways to add fractions. You can use any one you want, but you should make sure that the result of the operation is reduced so that the numerator and denominator have no common divisor (other than 1).

The purpose of this exercise is to write a class definition that includes a variety of methods, including constructors, static methods, instance methods, modifiers, and pure methods.

Chapter 12

Arrays of Objects

During the next three chapters, we will develop programs that work with playing cards and decks of cards. Here is an outline of the road ahead:

- In this chapter, we define a `Card` class and write methods that work with cards and arrays of cards.
- In Chapter 13.1, we define a `Deck` class that encapsulates an array of cards, and we write methods that operate on decks.
- In Chapter 14, we introduce a way to define new classes that extend existing classes. Then we use `Card` and `Deck` to implement the game *Crazy Eights*.

There are 52 cards in a standard deck. Each card belongs to one of four suits and one of 13 ranks. The suits are Clubs, Diamonds, Hearts, and Spades. The ranks are Ace, 2, 3, 4, 5, 6, 7, 8, 9, 10, Jack, Queen, and King.

If you are unfamiliar with traditional playing cards, now would be a good time to get a deck or read through https://en.wikipedia.org/wiki/Standard_52-card_deck.

12.1 Card Objects

If we want to define a class to represent a playing card, it is pretty clear what the instance variables should be: `rank` and `suit`. It is not as obvious what types they should be.

One possibility is a `String` containing things like `"Spade"` for suits and `"Queen"` for ranks. A problem with this choice is that it would not be easy to compare cards to see which had a higher rank or suit.

An alternative is to use integers to **encode** the ranks and suits. By encode, we *don't* mean to encrypt or translate into a secret code. We mean to define a mapping between a sequence of numbers and the things we want to represent.

Here is a mapping for suits:

Clubs	\mapsto	0
Diamonds	\mapsto	1
Hearts	\mapsto	2
Spades	\mapsto	3

We use the mathematical symbol \mapsto to make it clear that these mappings are not part of the program. They are part of the program design, but they never appear explicitly in the code.

Each of the numerical ranks (2 through 10) maps to the corresponding integer. For the face cards, we can use:

Ace	\mapsto	1
Jack	\mapsto	11
Queen	\mapsto	12
King	\mapsto	13

With this encoding, the class definition for the `Card` type looks like this:

```
public class Card {
    private int rank;
    private int suit;

    public Card(int rank, int suit) {
        this.rank = rank;
        this.suit = suit;
    }
}
```

The instance variables are `private`: we can access them from inside this class, but not from other classes.

The constructor takes a parameter for each instance variable. To create a `Card` object, we use the `new` operator:

```
Card threeOfClubs = new Card(3, 0);
```

The result is a reference to a `Card` that represents the “3 of Clubs”.

12.2 Card toString

When you create a new class, the first step is to declare the instance variables and write constructors. A good next step is to write `toString`, which is useful for debugging and incremental development.

To display `Card` objects in a way that humans can read easily, we need to “decode” the integer values as words. A natural way to do that is with an array of `Strings`. For example, we can create the array like this:

```
String[] suits = new String[4];
```

And then assign values to the elements:

```
suits[0] = "Clubs";
suits[1] = "Diamonds";
suits[2] = "Hearts";
suits[3] = "Spades";
```

Or we can create the array and initialize the elements at the same time, as we saw in Section 7.3:

```
String[] suits = {"Clubs", "Diamonds", "Hearts", "Spades"};
```

The memory diagram in Figure 12.1 shows the result. Each element of the array is a reference to a `String`.

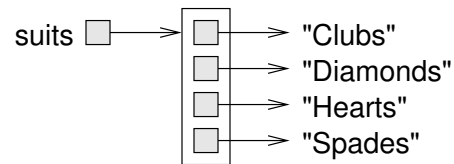

Figure 12.1: Memory diagram of an array of strings.

We also need an array to decode the ranks:

```
String[] ranks = {null, "Ace", "2", "3", "4", "5", "6",  
                  "7", "8", "9", "10", "Jack", "Queen", "King"};
```

The zeroth element should never be used, because the only valid ranks are 1–13. We set it to `null` to indicate an unused element.

Using these arrays, we can create a meaningful `String` using `suit` and `rank` as indexes.

```
String s = ranks[this.rank] + " of " + suits[this.suit];
```

The expression `ranks[this.rank]` means “use the instance variable `rank` from `this` object as an index into the array `ranks`.” We select the string for `this.suit` in a similar way.

Now we can wrap all the previous code in a `toString` method.

```
public String toString() {  
    String[] ranks = {null, "Ace", "2", "3", "4", "5", "6",  
                    "7", "8", "9", "10", "Jack", "Queen", "King"};  
    String[] suits = {"Clubs", "Diamonds", "Hearts", "Spades"};  
    String s = ranks[this.rank] + " of " + suits[this.suit];  
    return s;  
}
```

When we display a card, `println` automatically calls `toString`. The output of the following code is Jack of Diamonds.

```
Card card = new Card(11, 1);
System.out.println(card);
```

12.3 Class Variables

So far we have seen local variables, which are declared inside a method, and instance variables, which are declared in a class definition, usually before the method definitions. Now it's time to learn about **class variables**. They are shared across all instances of the class.

Like instance variables, class variables are defined in a class definition, before the method definitions. But they are identified by the keyword `static`. Here is a version of `Card` where `RANKS` and `SUITS` are defined as class variables:

```
public class Card {

    public static final String[] RANKS = {
        null, "Ace", "2", "3", "4", "5", "6", "7",
        "8", "9", "10", "Jack", "Queen", "King"};

    public static final String[] SUITS = {
        "Clubs", "Diamonds", "Hearts", "Spades"};

    // instance variables and constructors go here

    public String toString() {
        return RANKS[this.rank] + " of " + SUITS[this.suit];
    }
}
```

Class variables are allocated when the program begins and persist until the program ends. In contrast, instance variables like `rank` and `suit` are allocated when the program creates `new` objects, and they are deleted when the object is garbage-collected.

Class variables are often used to store constant values that are needed in several places. In that case, they should also be declared as `final`. Note that whether a variable is `static` or `final` involves two separate considerations: `static` means the variable is *shared*, and `final` means the variable is *constant*.

Naming `static final` variables with capital letters is a common convention that makes it easier to recognize their role in the class. In the `toString` method, we refer to `SUITS` and `RANKS` as if they were local variables, but we can tell that they are class variables.

One advantage of defining `SUITS` and `RANKS` as class variables is that they don't need to be created (and garbage-collected) every time `toString` is called. They may also be needed in other methods and classes, so it's helpful to make them available everywhere. Since the array variables are `final`, and the strings they reference are immutable, there is no danger in making them `public`.

12.4 The `compareTo` Method

As we saw in Section 11.7, it's helpful to create an `equals` method to test whether two objects are equivalent.

```
public boolean equals(Card that) {
    return this.rank == that.rank
        && this.suit == that.suit;
}
```

It would also be nice to have a method for comparing cards, so we can tell if one is higher or lower than another. For primitive types, we can use comparison operators like `<` and `>` to compare values. But these operators don't work for object types.

For strings, Java provides a `compareTo` method, as we saw in Section 6.10. We can write our own version of `compareTo` for the classes that we define, like we did for the `equals` method.

Some types are “totally ordered”, which means that you can compare any two values and tell which is bigger. Integers and strings are totally ordered. Other types are “unordered”, which means that there is no meaningful way

to say that one element is bigger than another. In Java, the `boolean` type is unordered; if you try to compare `true < false`, you get a compiler error.

The set of playing cards is “partially ordered”, which means that sometimes we can compare cards and sometimes not. For example, we know that the 3 of Clubs is higher than the 2 of Clubs, and the 3 of Diamonds is higher than the 3 of Clubs. But which is better, the 3 of Clubs or the 2 of Diamonds? One has a higher rank, but the other has a higher suit.

To make cards comparable, we have to decide which is more important: rank or suit. The choice is arbitrary, and it might be different for different games. But when you buy a new deck of cards, it comes sorted with all the Clubs together, followed by all the Diamonds, and so on. So for now, let’s say that suit is more important. With that decided, we can write `compareTo` as follows:

```
public int compareTo(Card that) {
    if (this.suit < that.suit) {
        return -1;
    }
    if (this.suit > that.suit) {
        return 1;
    }
    if (this.rank < that.rank) {
        return -1;
    }
    if (this.rank > that.rank) {
        return 1;
    }
    return 0;
}
```

`compareTo` returns `-1` if `this` is a lower card, `+1` if `this` is a higher card, and `0` if `this` and `that` are equivalent. It compares suits first. If the suits are the same, it compares ranks. If the ranks are also the same, it returns `0`.

12.5 Cards are Immutable

The instance variables of `Card` are `private`, so they can’t be accessed from other classes. We can provide getters to allow other classes to read the `rank`

and suit values:

```
public int getRank() {  
    return this.rank;  
}  
  
public int getSuit() {  
    return this.suit;  
}
```

Whether or not to provide setters is a design decision. If we did, cards would be mutable, so you could transform one card into another. That is probably not a feature we want, and in general, mutable objects are more error-prone. So it might be better to make cards immutable. To do that, all we have to do is *not* provide any modifier methods (including setters).

That's easy enough, but it is not foolproof, because a fool might come along later and add a modifier. We can prevent that possibility by declaring the instance variables `final`:

```
public class Card {  
    private final int rank;  
    private final int suit;  
  
    ...  
}
```

You can still assign values to these variables inside a constructor. But if someone writes a method that tries to modify these variables, they'll get a compiler error. This kind of safeguard helps prevent future mistakes and hours of debugging.

12.6 Arrays of Cards

Just as you can create an array of `String` objects, you can create an array of `Card` objects. The following statement creates an array of 52 cards. Figure 12.2 shows the memory diagram for this array.

```
Card[] cards = new Card[52];
```

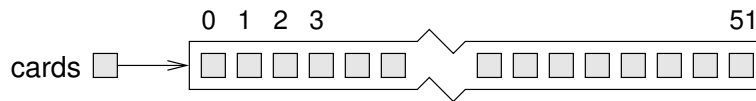

Figure 12.2: Memory diagram of an unpopulated `Card` array.

Although we call it an “array of cards”, the array contains *references* to cards; it does not contain the `Card` objects themselves. Initially the references are all `null`.

Even so, you can access the elements of the array in the usual way:

```
if (cards[0] == null) {
    System.out.println("No card yet!");
}
```

But if you try to access the instance variables of non-existent `Card` objects, you will get a `NullPointerException`.

```
System.out.println(cards[0].rank); // NullPointerException
```

That code won’t work until we put cards in the array. One way to populate the array is to write nested `for` loops:

```
int index = 0;
for (int suit = 0; suit <= 3; suit++) {
    for (int rank = 1; rank <= 13; rank++) {
        cards[index] = new Card(rank, suit);
        index++;
    }
}
```

The outer loop iterates suits from 0 to 3. For each suit, the inner loop iterates ranks from 1 to 13. Since the outer loop runs 4 times, and the inner loop runs 13 times for each suit, the body is executed 52 times.

We use a separate variable `index` to keep track of where in the array the next card should go. Figure 12.3 shows what the array looks like after the first two cards have been created.

When you work with arrays, it is convenient to have a method that displays the contents. We have seen the pattern for traversing an array several times, so the following method should be familiar.

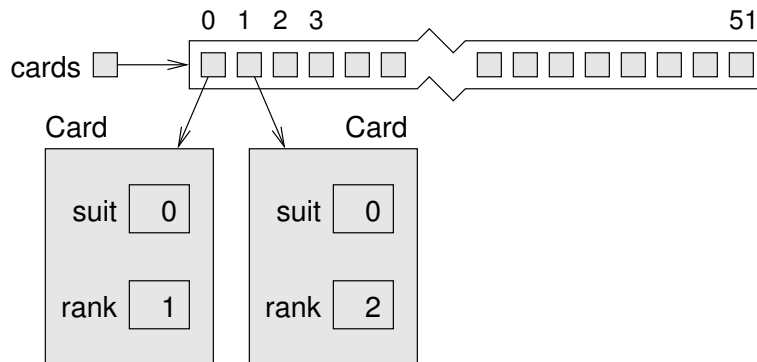

Figure 12.3: Memory diagram of a `Card` array with two cards.

```
public static void printDeck(Card[] cards) {
    for (Card card : cards) {
        System.out.println(card);
    }
}
```

Since `cards` has type `Card[]`, pronounced “card array”, an element of `cards` has type `Card`. So `println` invokes the `toString` method in the `Card` class.

Then again, we don’t have to write our own `printDeck` method. The `Arrays` class provides a `toString` method that invokes `toString` on the elements of an array and concatenates the results.

```
System.out.println(Arrays.toString(cards))
```

12.7 Sequential Search

The next method we’ll write is `search`, which takes an array of cards and a `Card` object as parameters. It returns the index where the `Card` appears in the array, or `-1` if it doesn’t. This version of `search` uses the algorithm we saw in Section 7.5, which is called **sequential search**:

```
public static int search(Card[] cards, Card target) {
    for (int i = 0; i < cards.length; i++) {
        if (cards[i].equals(target)) {
            return i;
        }
    }
    return -1;
}
```

The method returns as soon as it discovers the card, which means we don't have to traverse the entire array if we find the target. If we get to the end of the loop, we know the card is not in the array.

If the cards in the array are not in order, there is no way to search faster than sequential search. We have to look at every card, because otherwise we can't be certain the card we want is not there. But if the cards are in order, we can use better algorithms.

Sequential search is relatively inefficient, especially for large arrays. If you pay the price to keep the array sorted, finding elements becomes much easier.

12.8 Binary Search

When you look for a word in a dictionary, you don't search page by page from front to back. Since the words are in alphabetical order, you probably use a **binary search** algorithm:

1. Start on a page near the middle of the dictionary.
2. Compare a word on the page to the word you are looking for. If you find it, stop.
3. If the word on the page comes before the word you are looking for, flip to somewhere later in the dictionary and go to step 2.
4. If the word on the page comes after the word you are looking for, flip to somewhere earlier in the dictionary and go to step 2.

This algorithm is much faster than sequential search, because it rules out half of the remaining words each time you make a comparison. If at any point you find two adjacent words on the page, and your word comes between them, you can conclude that your word is not in the dictionary.

Getting back to the array of cards, we can write a faster version of `search` if we know the cards are in order:

```
public static int binarySearch(Card[] cards, Card target) {
    int low = 0;
    int high = cards.length - 1;
    while (low <= high) {
        int mid = (low + high) / 2;           // step 1
        int comp = cards[mid].compareTo(target);

        if (comp == 0) {                     // step 2
            return mid;
        } else if (comp < 0) {              // step 3
            low = mid + 1;
        } else {                             // step 4
            high = mid - 1;
        }
    }
    return -1;
}
```

First, we declare `low` and `high` variables to represent the range we are searching. Initially we search the entire array, from 0 to `cards.length - 1`.

Inside the `while` loop, we repeat the four steps of binary search:

1. Choose an index between `low` and `high` – call it `mid` – and compare the card at `mid` to the target.
2. If you found the target, return its index (which is `mid`).
3. If the card at `mid` is lower than the target, search the range from `mid + 1` to `high`.
4. If the card at `mid` is higher than the target, search the range from `low` to `mid - 1`.

If `low` exceeds `high`, there are no cards in the range, so we terminate the loop and return `-1`.

This algorithm only depends on the `compareTo` method of the object, so we can use this code with object type that provides `compareTo`.

12.9 Tracing the Code

To see how binary search works, it's helpful to add the following print statement at the beginning of the loop:

```
System.out.println(low + ", " + high);
```

Using a sorted deck of cards, we can search for the “Jack of Clubs” like this:

```
Card card = new Card(11, 0);  
System.out.println(binarySearch(cards, card));
```

We expect to find this card at position 10 (since the “Ace of Clubs” is at position 0). Here is the output of `binarySearch`:

```
0, 51  
0, 24  
0, 11  
6, 11  
9, 11  
10
```

You can see the range of cards shrinking as the `while` loop runs, until eventually index 10 is found. If we search for a card that's not in the array, like `new Card(15, 1)` the “15 of Diamonds”, we get the following:

```
0, 51  
26, 51  
26, 37  
26, 30  
26, 27  
-1
```

Each time through the loop, we cut the distance between `low` and `high` in half. After k iterations, the number of remaining cards is $52/2^k$. To find the number of iterations it takes to complete, we set $52/2^k = 1$ and solve for k . The result is $\log_2 52$, which is about 5.7. So we might have to look at 5 or 6 cards, as opposed to all 52 if we did a sequential search.

More generally, if the array contains n elements, binary search requires $\log_2 n$ comparisons, and sequential search requires n . For large values of n , binary search is substantially faster.

12.10 Vocabulary

encode: To represent one set of values using another set of values by constructing a mapping between them.

class variable: A variable declared within a class as `static`. There is only one copy of a class variable, no matter how many objects there are.

sequential search: An algorithm that searches array elements, one by one, until a target value is found.

binary search: An algorithm that searches a sorted array by starting in the middle, comparing an element to the target, and eliminating half of the remaining elements.

12.11 Exercises

The code for this chapter is in the `ch12` directory of `ThinkJavaCode2`. See page xix for instructions on how to download the repository. Before you start the exercises, we recommend that you compile and run the examples.

Exercise 12.1 Encapsulate the deck-building code from Section 12.6 in a method called `makeDeck` that takes no parameters and returns a fully-populated array of `Cards`.

Exercise 12.2 In some card games, Aces are ranked higher than Kings. Modify the `compareTo` method to implement this ordering.

Exercise 12.3 In Poker a “flush” is a hand that contains five or more cards of the same suit. A hand can contain any number of cards.

1. Write a method called `suitHist` that takes an array of cards as a parameter and that returns a histogram of the suits in the hand. Your solution should only traverse the array once as in Section 7.7.
2. Write a method called `hasFlush` that takes an array of cards as a parameter and returns `true` if the hand contains a flush (and `false` otherwise).

Exercise 12.4 Working with cards is more fun if you can display them on the screen. If you have not already read Appendix C about 2D graphics, you should read it before working on this exercise. In the code directory for this chapter, `ch12`, you will find:

- `cardset-oxymoron`: A directory containing images of playing cards.
- `CardTable.java`: A sample program that demonstrates how to read and display images.

This code demonstrates the use of a 2D array, specifically an array of images. The declaration looks like this:

```
private Image[][] images;
```

The variable `images` refers to a 2D array of `Image` objects, which are defined in the `java.awt` package. Here’s the code that creates the array itself:

```
images = new Image[14][4];
```

The array has 14 rows (one for each rank plus an unused row for rank 0) and 4 columns (one for each suit). Here’s the loop that populates the array:

```
String cardset = "cardset-oxymoron";
String suits = "cdhs";

for (int suit = 0; suit <= 3; suit++) {
    char c = suits.charAt(suit);

    for (int rank = 1; rank <= 13; rank++) {
        String s = String.format("%s/%02d%c.gif",
                                cardset, rank, c);
        images[rank][suit] = new ImageIcon(s).getImage();
    }
}
```

The variable `cardset` contains the name of the directory that contains the image files. `suits` is a string that contains the single-letter abbreviations for the suits. These strings are used to assemble `s`, which contains the filename for each image. For example, when `rank=1` and `suit=2`, the value of `s` is `"cardset-oxymoron/01h.gif"`, which is an image of the Ace of Hearts.

The last line of the loop reads the image file, extracts an `Image` object, and assigns it to a location in the array, as specified by the indexes `rank` and `suit`. For example, the image of the Ace of Hearts is stored in row 1, column 2.

If you compile and run `CardTable.java`, you should see images of a deck of cards laid out on a green table. You can use this class as a starting place to implement your own card games.

As a starting place, try placing cards on the table in the starting configuration for the solitaire game Klondike (see [https://en.wikipedia.org/wiki/Klondike_\(solitaire\)](https://en.wikipedia.org/wiki/Klondike_(solitaire))).

You can get the image for the back of the card by reading the file `back192.gif`.

Chapter 13

Objects of Arrays

In the previous chapter, we defined a class to represent cards and used an array of `Card` objects to represent a deck. In this chapter, we take additional steps toward object-oriented programming.

First we define a class to represent a deck of cards. Then we present algorithms for shuffling and sorting decks. Finally, we introduce `ArrayList` from the Java library and use it to represent collections of cards.

13.1 Decks of Cards

Here is the beginning of a `Deck` class that encapsulates an array of `Card` objects:

```
public class Deck {
    private Card[] cards;

    public Deck(int n) {
        this.cards = new Card[n];
    }

    public Card[] getCards() {
        return this.cards;
    }
}
```

The constructor initializes the instance variable with an array of *n* cards, but it doesn't create any *Card* objects. Figure 13.1 shows what a *Deck* looks like with no cards.

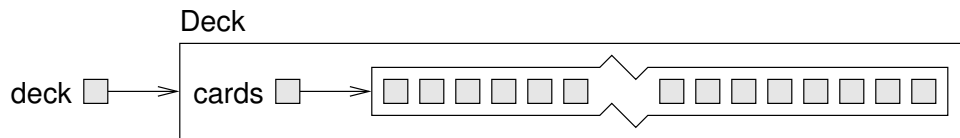

Figure 13.1: Memory diagram of an unpopulated *Deck* object.

We'll add another constructor that creates a standard 52-card array and populates it with *Card* objects:

```
public Deck() {
    this.cards = new Card[52];
    int index = 0;
    for (int suit = 0; suit <= 3; suit++) {
        for (int rank = 1; rank <= 13; rank++) {
            this.cards[index] = new Card(rank, suit);
            index++;
        }
    }
}
```

This method is similar to the example in Section 12.6; we just turned it into a constructor. We can use it to create a complete *Deck* like this:

```
Deck deck = new Deck();
```

Now that we have a *Deck* class, we have a logical place to put methods that pertain to decks. Looking at the methods we have written so far, one obvious candidate is `printDeck` from Section 12.6. Here's how it looks, rewritten as an instance method of *Deck*:

```
public void print() {
    for (Card card : this.cards) {
        System.out.println(card);
    }
}
```

Notice that when we transform a static method into an instance method, the code is shorter. Here's how we invoke it:

```
deck.print()
```

13.2 Shuffling Decks

For most card games, you have to shuffle the deck; that is, put the cards in a random order. In Section 7.6 we saw how to generate random numbers, but it is not obvious how to use them to shuffle a deck.

One possibility is to model the way humans shuffle; for example, we could divide the deck in two halves and then choosing alternately from each one. Since humans usually don't shuffle perfectly, after about seven iterations the order of the deck is pretty well randomized.

But a computer program would have the annoying property of doing a perfect shuffle every time, which is not very random. In fact, after eight perfect shuffles, you would find the deck back in the order you started in! For more on this, see https://en.wikipedia.org/wiki/Faro_shuffle.

A better shuffling algorithm is to traverse the deck one card at a time, and at each iteration, choose two cards and swap them. To outline this algorithm, we'll use a combination of Java statements and English comments. This technique is sometimes called **pseudocode**.

```
public void shuffle() {
    for each index i {
        // choose a random number between i and length - 1
        // swap the ith card and the randomly-chosen card
    }
}
```

The nice thing about pseudocode is that it often makes clear what other methods you are going to need. In this case, we need a method that chooses a random integer between **low** and **high**, and a method that takes two indexes and swaps the cards at those positions.

```
private static int randomInt(int low, int high) {
    // return a random number between low and high,
    // including both
}

private void swapCards(int i, int j) {
    // swap the ith and the jth cards in the array
}
```

Methods like `randomInt` and `swapCards` are called **helper methods**, because they help you solve parts of the problem. Helper methods are often `private`, because they are only used by methods in the class, and are not needed by methods in other classes.

The process of writing pseudocode first and then writing helper methods to make it work is a kind of **top-down design** (see https://en.wikipedia.org/wiki/Top-down_and_bottom-up_design). It is an alternative to “incremental development” and “encapsulation and generalization”, the other design processes you have seen in this book.

One of the exercises at the end of the chapter asks you to write the helper methods `randomInt` and `swapCards`, and use them to implement `shuffle`.

13.3 Selection Sort

Now that we have shuffled the deck, we need a way to put it back in order. There is an algorithm for sorting that is ironically similar to the algorithm for shuffling. It’s called **selection sort**, because it works by traversing the array repeatedly and selecting the lowest (or highest) remaining card each time.

During the first iteration, we find the lowest card and swap it with the card in the 0th position. During the i th iteration, we find the lowest card to the right of i and swap it with the i th card. Here is pseudocode for selection sort:

```
public void selectionSort() {
    for each index i {
        // find the lowest card at or to the right of i
        // swap the ith card and the lowest card found
    }
}
```

Again, the pseudocode helps with the design of the helper methods. For this algorithm we can reuse `swapCards` from the previous section, so we only need a method to find the lowest card; we'll call it `indexLowest`.

```
private int indexLowest(int low, int high) {  
    // find the lowest card between low and high  
}
```

One of the exercises at the end of the chapter asks you to write `indexLowest`, and then use it and `swapCards` to implement `selectionSort`.

13.4 Merge Sort

Selection sort is a simple algorithm, but it is not very efficient. To sort n items, it has to traverse the array $n - 1$ times. Each traversal takes an amount of time proportional to n . The total time, therefore, is proportional to n^2 .

We will develop a more efficient algorithm called **merge sort**. To sort n items, merge sort takes time proportional to $n \log_2 n$. That may not seem impressive, but as n gets big, the difference between n^2 and $n \log_2 n$ can be enormous.

For example, \log_2 of one million is around 20. So if you had to sort a million numbers, merge sort would require 20 million steps. But selection sort would require one trillion steps!

The idea behind merge sort is this: if you have two decks, each of which has already been sorted, you can quickly merge them into a single, sorted deck. Try this out with a deck of cards:

1. Form two decks with about 10 cards each, and sort them so they are face up with the lowest cards on top. Place the decks in front of you.
2. Compare the top card from each deck and choose the lower one. Flip it over and add it to the merged deck.
3. Repeat step 2 until one of the decks is empty. Then take the remaining cards and add them to the merged deck.

The result should be a single sorted deck. In the next few sections, we'll explain how to implement this algorithm in Java.

13.5 Subdecks

The first step of merge sort is to split the deck into two “subdecks”, each with about half of the cards. So we need a method that takes a deck, and a range of indexes, and returns a new deck that contains the specified subset of cards.

```
public Deck subdeck(int low, int high) {
    Deck sub = new Deck(high - low + 1);
    for (int i = 0; i < sub.cards.length; i++) {
        sub.cards[i] = this.cards[low + i];
    }
    return sub;
}
```

The first line creates an unpopulated `Deck` object that contains an array of `null` references. Inside the `for` loop, the subdeck gets populated with references to `Card` objects.

The length of the subdeck is `high - low + 1`, because both the low card and the high card are included. This sort of computation can be confusing, and forgetting the “+ 1” often leads to **off-by-one** errors. Drawing a picture is usually the best way to avoid them.

Figure 13.2 is a memory diagram of a subdeck with `low = 0` and `high = 4`. The result is a hand with five cards that are *shared* with the original deck; that is, they are aliased.

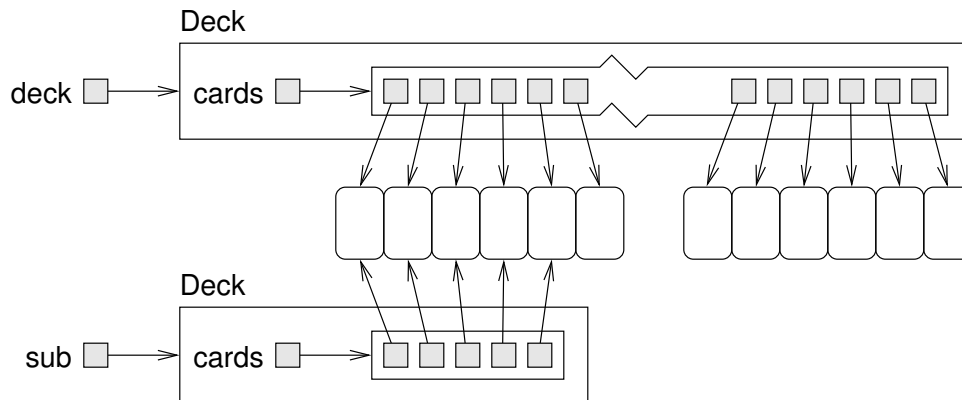

Figure 13.2: Memory diagram showing the effect of `subdeck`.

Aliasing might not be a good idea, because changes to shared cards would be reflected in multiple decks. But since `Card` objects are immutable, this kind of aliasing is not a problem. And it saves some memory because we don't create duplicate `Card` objects.

13.6 Merging Decks

The next helper method we need is `merge`, which takes two sorted subdecks and returns a new deck containing all cards from both decks, in order. Here's what the algorithm looks like in pseudocode, assuming the subdecks are named `d1` and `d2`:

```
private static Deck merge(Deck d1, Deck d2) {
    // create a new deck big enough for all the cards

    // use the index i to keep track of where we are at in
    // the first deck, and the index j for the second deck
    int i = 0;
    int j = 0;

    // the index k traverses the result deck
    for (int k = 0; k < d3.length; k++) {

        // if d1 is empty, use top card from d2
        // if d2 is empty, use top card from d1
        // otherwise, compare the top two cards

        // add lowest card to the new deck at k
        // increment i or j (depending on card)
    }
    // return the new deck
}
```

An exercise at the end of the chapter asks you to implement `merge`. It's a little tricky, so be sure to test it with different subdecks. Once your `merge` method is working, you can use it to write a simplified version of merge sort:

```
public Deck almostMergeSort() {  
    // divide the deck into two subdecks  
    // sort the subdecks using selectionSort  
    // merge the subdecks, return the result  
}
```

If you have working versions of `subdeck`, `selectionSort`, and `merge`, you should have no trouble getting this method working. But it is still not very efficient, because it uses `selectionSort` to sort the subdecks. We can make it more efficient if we use `mergeSort` instead, but that means we have to make it recursive!

13.7 Adding Recursion

To make `mergeSort` work recursively, you have to add a base case; otherwise it repeats forever.

The simplest base case is a subdeck with 1 cards. If there is only one card, it can't be out of order, so we consider it sorted. And if it is already sorted, we can just return it.

And it will turn out to be convenient if we handle another base case, a subdeck with 0 cards. By the same logic, if there are no cards, they can't be out of order. So we consider an empty deck to be sorted, and return it.

With these base cases, a recursive version of `mergeSort` looks like this:

```
public Deck mergeSort() {  
    // if the deck has 0 or 1 cards, return it  
    // otherwise, divide the deck into two subdecks  
    // sort the subdecks using mergeSort  
    // merge the subdecks  
    // return the result  
}
```

As usual, there are two ways to think about recursive programs: you can follow the flow of execution, or you can make the “leap of faith” (see Section 8.4). This example should encourage you to make the leap of faith.

When you use `selectionSort` to sort the subdecks, you don't feel compelled to follow the flow of execution. You assume it works because you already debugged it. When you make `mergeSort` recursive, you just replace one sorting algorithm with another. There is no reason to read the program differently.

Well, almost. You have to think about the base cases and make sure that you reach them. But other than that, writing the recursive version should be no problem.

As an exercise at the end of this chapter, you'll have a chance to finish it off.

13.8 Static Context

Figure 13.3 shows a UML class diagram for `Deck`, including the instance variable, `cards`, and the methods we have so far. In UML diagrams, `private` attributes and methods begin with a minus sign (-) and `static` methods are underlined.

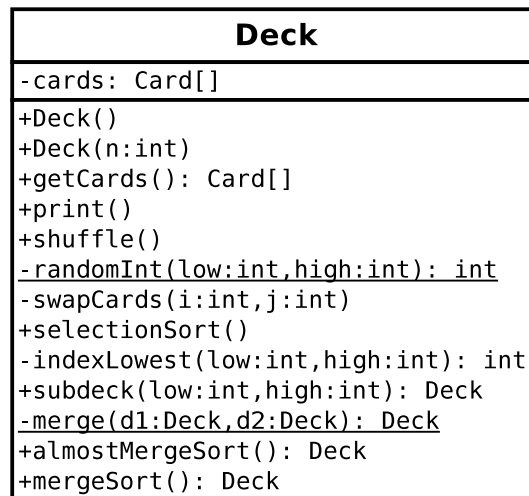

Figure 13.3: UML diagram for the `Deck` class.

The helper methods `randomInt` and `merge` are `static`, because they do not read or write any instance variables. All other methods are instance methods, because they access the instance variable, `cards`.

When you have static methods and instance methods in the same class, it is easy to get them confused.

To invoke an instance method, you need an instance:

```
Deck deck = new Deck();  
deck.print(); // correct
```

`Deck` with a capital `D` is a class, and `deck` with a lowercase `d` is an object.

If you try to invoke `print` like this:

```
Deck.print(); // wrong!
```

You get a compiler error like this:

```
Non-static method print() cannot be referenced from a  
static context.
```

By “static context”, the compiler means you are trying to invoke a method in a context that requires a static method.

On the other hand, if you have a `Deck` object, you can use it to invoke a static method:

```
Deck deck = new Deck();  
int i = deck.randomInt(0, 51); // legal, but not good style
```

This is legal, but it is not considered good style, because someone reading this code would expect `randomInt` to be an instance method.

Another common error is to use `this` in a static method. For example, if you write something like this:

```
private static Deck merge(Deck d1, Deck d2) {  
    return this.cards; // wrong!  
}
```

You get a compiler error like this:

```
Non-static variable this cannot be referenced from a  
static context.
```

The problem is that `cards` is an instance variable, so it is “non-static”, so you can’t access it from a static method. In general, you can’t use `this` in a static method, because a static method is not invoked on an object.

For beginners, error messages about non-static context can be confusing and frustrating. We hope this section helps.

13.9 Piles of Cards

Now that we have classes that represent cards and decks, let’s use them to make a game. One of the simplest card games that children play is called “War” (see [https://en.wikipedia.org/wiki/War_\(card_game\)](https://en.wikipedia.org/wiki/War_(card_game))).

In this game, the deck is divided two piles, one for each player. During each round, each player takes the top card from their pile and places it, face up, in the center. Whoever has the highest ranking card, ignoring suit, takes the two cards and adds them to the bottom of their pile. The game continues until one player has won the entire deck.

We could use the `Deck` class to represent the individual piles. However, our implementation of `Deck` uses a `Card` array, and the length of an array can’t change. As the game progresses, we need to be able to add and remove cards from the piles.

We can solve this problem with an `ArrayList`, which is in the `java.util` package. An `ArrayList` is a **collection**, which is an object that contains other objects. It provides methods to add and remove elements, and it grows and shrinks automatically.

We define a new class named `Pile` to represent a pile of cards. It uses an `ArrayList` to store `Card` objects.

```
public class Pile {
    private ArrayList<Card> cards;

    public Pile() {
        this.cards = new ArrayList<Card>();
    }
}
```

When you declare an `ArrayList`, you specify the type it contains in angle brackets (`<>`). This declaration says that `cards` is not just an `ArrayList`; it's an `ArrayList` of `Card` objects.

The constructor initializes `this.cards` with an empty `ArrayList`.

Now let's think about the methods we need to play the game.

At the beginning of each round, each player draws a card from the top of their pile. So we define a method to do that:

```
public Card popCard() {
    return this.cards.remove(0); // from the top of the pile
}
```

`popCard` removes the `Card` at the beginning of the `ArrayList`, which we think of as the top of the pile.

Because we use `ArrayList.remove`, it automatically shifts the remaining cards to fill the gap.

At the end of each round, the winner adds cards to the bottom of their pile. So we define a method to do that:

```
public void addCard(Card card) {
    this.cards.add(card); // to the bottom of the pile
}
```

`ArrayList` provides a method, `add`, that adds an element to the end of the collection, which we think of as the bottom of the pile.

To know when to stop the game, have to check if one of the piles is empty. Here's a method to do that:

```
public boolean isEmpty() {
    return this.cards.isEmpty();
}
```

So far, these methods don't do very much; they just invoke methods on the instance variable, `cards`. Methods like these are called **wrapper methods** because they wrap one method with another.

Finally, to start the game, we need to divide the deck into two equal parts. We can do that with `subdeck` from Section 13.5 and a new method, `addDeck`:

```
public void addDeck(Deck deck) {
    for (Card card : deck.getCards()) {
        this.cards.add(card);
    }
}
```

`addDeck` takes a `Deck` object, loops through the cards, and adds them to the `Pile`. Notice that it does not remove the cards from the `Deck`, so the `Deck` and the `Pile` share cards. But that won't be a problem.

13.10 Playing War

Now we can use `Deck` and `Pile` to implement the game. We'll start by creating a deck and shuffling:

```
Deck deck = new Deck();
deck.shuffle();
```

Then we divide the `Deck` into two piles:

```
Pile p1 = new Pile();
p1.addDeck(deck.subdeck(0, 25));

Pile p2 = new Pile();
p2.addDeck(deck.subdeck(26, 51));
```

The game itself is a loop that repeats until one of the piles is empty. At each iteration, we draw a card from each pile and compare their ranks.

```
while (!p1.isEmpty() && !p2.isEmpty()) {
    // pop a card from each pile
    Card c1 = p1.popCard();
    Card c2 = p2.popCard();

    // compare the cards
    int diff = c1.getRank() - c2.getRank();
    if (diff > 0) {
        p1.addCard(c1);
        p1.addCard(c2);
    } else if (diff < 0) {
        p2.addCard(c1);
        p2.addCard(c2);
    } else {
        // it's a tie
    }
}
```

If the two cards have the same rank, it's a tie. In that case, each player draws four more cards. Whoever has the higher fourth card takes all cards in play. If there's another tie, they draw another four cards, and so on.

One of the exercises at the end of this chapter asks you to implement the `else` block when there's a tie.

After the `while` loop ends, we display the winner based on which pile is not empty.

```
if (p2.isEmpty()) {
    System.out.println("Player 1 wins!");
} else {
    System.out.println("Player 2 wins!");
}
```

`ArrayList` provides many other methods that we didn't use for this example. Take a minute to read about them at <https://docs.oracle.com/javase/9/docs/api/java/util/ArrayList.html>.

13.11 Vocabulary

pseudocode: A way of designing programs by writing rough drafts in a combination of English and Java.

helper method: A method that implements part of a more complex algorithm; often it is not particularly useful on its own.

top-down design: Breaking down a problem into sub-problems, and solving each sub-problem one at a time.

selection sort: A simple sorting algorithm that searches for the smallest or largest element n times.

merge sort: A recursive sorting algorithm that divides an array into two parts, sorts each part (using merge sort), and merges the results.

off-by-one: A common programming mistake that results in iterating one time too many, or too few.

static context: The parts of a class that run without reference to a specific instance of the class.

collection: A Java library class, like `ArrayList`, that represents a group of objects.

wrapper method: A method that calls another method without doing much additional work.

13.12 Exercises

The code for this chapter is in the `ch13` directory of `ThinkJavaCode2`. See page xix for instructions on how to download the repository. Before you start the exercises, we recommend that you compile and run the examples.

Exercise 13.1 Write a `toString` method for the `Deck` class. It should return a single string that represents the cards in the deck. When it's printed, this string should display the same results as the `print` method in Section 13.1.

Hint: You can use the `+` operator to concatenate strings, but it is not very efficient. Consider using `java.lang.StringBuilder` instead; see Section 10.11.

Exercise 13.2 The goal of this exercise is to implement the shuffling algorithm from this chapter.

1. In the repository for this book, you should find the file named `Deck.java`. Check that you can compile it in your environment.
2. Implement the `randomInt` method. You can use the `nextInt` method provided by `java.util.Random`, which we saw in Section 7.6.
Hint: To avoid creating a `Random` object every time `randomInt` is invoked, consider defining a class variable.
3. Write a `swapCards` method that takes two indexes and swaps the cards at the given locations.
4. Fill in the `shuffle` method using the algorithm in Section 13.2.

Exercise 13.3 The goal of this exercise is to implement the sorting algorithms from this chapter. Use the `Deck.java` file from the previous exercise, or create a new one from scratch.

1. Implement the `indexLowest` method. Use the `Card.compareTo` method to find the lowest card in a given range of the deck, from `lowIndex` to `highIndex`, including both.
2. Fill in `selectionSort` using the algorithm in Section 13.3.
3. Using the pseudocode in Section 13.4, implement the `merge` method. The best way to test it is to build and shuffle a deck. Then use `subdeck` to form two small subdecks, and use selection sort to sort them. Finally, pass the two halves to `merge` and see if it works.
4. Fill in `almostMergeSort`, which divides the deck in half, then uses `selectionSort` to sort the two halves, and uses `merge` to create a new, sorted deck. You should be able to reuse code from the previous step.
5. Implement `mergeSort` recursively. Remember that `selectionSort` is a modifier and `mergeSort` is a pure method, which means that they get invoked differently:

```
deck.selectionSort();    // modifies an existing deck
deck = deck.mergeSort(); // replaces old deck with new
```

Exercise 13.4 You can learn more about the sorting algorithms presented in this chapter at <https://www.toptal.com/developers/sorting-algorithms>. This site provides explanations of the algorithms, along with animations that show how they work. It also includes an analysis of their efficiency.

For example, “insertion sort” is an algorithm that inserts elements into place, one at a time. Read about it on the website and play the animations. Then write a method named `insertionSort` that implements this algorithm.

One goal of this exercise is to practice top-down design. Your solution should use a helper method, named `insert`, that implements the inner loop of the algorithm. `insertionSort` should invoke this method $n - 1$ times.

Exercise 13.5 Find and open the file `War.java` in the repository. The `main` method contains all the code from the last section of this chapter. Check that you can compile and run this code before proceeding.

The program is incomplete; it does not handle the case when two cards have the same rank. Finish implementing the `main` method, beginning at the line that says: `// it's a tie.`

When there's a tie, draw three cards from each pile and store them in a collection, along with the original two. Then draw one more card from each pile and compare them. Whoever wins the tie takes all ten of these cards.

If one pile does not have at least four cards, the game ends immediately. If a tie ends with a tie, draw three more cards, and so on.

Notice that this program depends on `Deck.shuffle` so you might have to do Exercise 13.2 first.

Chapter 14

Extending Classes

In this chapter, we will present a comprehensive example of object-oriented programming. *Crazy Eights* is a classic card game for two or more players. The main objective is to be the first player to get rid of all your cards. Here's how to play:

- Deal five or more cards to each player, and then deal one card face up to create the “discard pile”. Place the remaining cards face down to create the “draw pile”.
- Each player takes turns placing a single card on the discard pile. The card must match the rank or suit of the previously played card, or be an eight, which is a “wild card”.
- When players don't have a matching card or an eight, they must draw new cards until they get one.
- If the draw pile ever runs out, the discard pile is shuffled (except the top card) and becomes the new draw pile.
- As soon as a player has no cards, the game ends and all other players score penalty points for their remaining cards. Eights are worth 20, face cards are worth 10, and all others are worth their rank.

You can read https://en.wikipedia.org/wiki/Crazy_Eights for more details, but we have enough to get started.

14.1 CardCollection

To implement *Crazy Eights*, we need to represent a deck of cards, a discard pile, a draw pile, and a hand for each player. And we need to be able to deal, draw, and discard cards.

The `Deck` and `Pile` classes from the previous chapter meet some of these requirements. But unless we make some changes, neither of them can be used to represent a hand of cards that well.

Furthermore, `Deck` and `Pile` are essentially two versions of the same code: one based on arrays, and the other based on `ArrayList`. It would be helpful to combine their features into one class that meets the needs of both.

We will define a class named `CardCollection` and add the code we want one step at a time. Since this class will represent different piles and hands of cards, we'll add a `label` attribute to tell them apart.

```
public class CardCollection {  
  
    private String label;  
    private ArrayList<Card> cards;  
  
    public CardCollection(String label) {  
        this.label = label;  
        this.cards = new ArrayList<Card>();  
    }  
}
```

As with the `Pile` class, we need a way to add cards to the collection. Here is the `addCard` method from the previous chapter:

```
public void addCard(Card card) {  
    this.cards.add(card);  
}
```

Until now, we have used `this` explicitly to make it easy to identify attributes. Inside `addCard` and other instance methods, you can access instance variables without using the keyword `this`. So from here on, we will drop it:

```
public void addCard(Card card) {
    cards.add(card);
}
```

We also need to be able to remove cards from the collection. The following method takes an index, removes the card at that location, and shifts the following cards left to fill the gap:

```
public Card popCard(int i) {
    return cards.remove(i);
}
```

If we are dealing cards from a shuffled deck, we don't care which card gets removed. It is most efficient to choose the last one, so we don't have to shift any cards left. Here is an overloaded version of `popCard` that removes and returns the last card:

```
public Card popCard() {
    int i = size() - 1;    // from the end of the collection
    return popCard(i);
}
```

Notice that `popCard` uses `CardCollection`'s own `size` method, which in turn calls the `ArrayList`'s `size` method:

```
public int size() {
    return cards.size();
}
```

For convenience, `CardCollection` also provides an `empty` method that returns `true` when `size` is zero:

```
public boolean empty() {
    return cards.size() == 0;
}
```

To access the elements of an `ArrayList`, you can't use the array `[]` operator. Instead, you have to use the methods `get` and `set`. Here is a wrapper for `get`:

```
public Card getCard(int i) {
    return cards.get(i);
}
```

The `lastCard` method gets the last card (but doesn't remove it):

```
public Card lastCard() {
    int i = size() - 1;
    return cards.get(i);
}
```

In order to control the ways card collections are modified, we don't provide a wrapper for `set`. The only modifiers we provide are the two versions of `popCard` and the following version of `swapCards`:

```
public void swapCards(int i, int j) {
    Card temp = cards.get(i);
    cards.set(i, cards.get(j));
    cards.set(j, temp);
}
```

We use `swapCards` to implement `shuffle`, which we described in Section 13.2:

```
public void shuffle() {
    Random random = new Random();
    for (int i = size() - 1; i > 0; i--) {
        int j = random.nextInt(i + 1);
        swapCards(i, j);
    }
}
```

14.2 Inheritance

At this point we have a class that represents a collection of cards. It provides functionality common to decks of cards, piles of cards, hands of cards, and potentially other collections.

However, each kind of collection will be slightly different. Rather than add every possible feature to `CardCollection`, we can use **inheritance** to define subclasses. A **subclass** is a class that “extends” an existing class; that is, it has the attributes and methods of the existing class, plus more.

Here is the complete definition of our new and improved `Deck` class:

```
public class Deck extends CardCollection {  
  
    public Deck(String label) {  
        super(label);  
        for (int suit = 0; suit <= 3; suit++) {  
            for (int rank = 1; rank <= 13; rank++) {  
                addCard(new Card(rank, suit));  
            }  
        }  
    }  
}
```

The first line uses the keyword `extends` to indicate that `Deck` extends the class `CardCollection`. That means a `Deck` object has the same instance variables and methods as a `CardCollection`. Another way to say the same thing is that `Deck` “inherits from” `CardCollection`. We could also say that `CardCollection` is a **superclass**, and `Deck` is one of its subclasses.

In Java, classes may only extend one superclass. Classes that do not specify a superclass with `extends` automatically inherit from `java.lang.Object`. So in this example, `Deck` extends `CardCollection`, which in turn extends `Object`. The `Object` class provides the default `equals` and `toString` methods, among other things.

Constructors are *not* inherited, but all other `public` attributes and methods are. The only additional method in `Deck`, at least for now, is a constructor. So you can create a `Deck` object like this:

```
Deck deck = new Deck("Deck");
```

The first line of the constructor uses `super`, which is a keyword that refers to the superclass of the current class. When `super` is used like a method, as in this example, it invokes the constructor of the superclass.

So in this case, `super` invokes the `CardCollection` constructor, which initializes the attributes `label` and `cards`. When it returns, the `Deck` constructor resumes and populates the (empty) `ArrayList` with `Card` objects.

That’s it for the `Deck` class. Next we need a way to represent a hand, which is the collection of cards held by a player, and a pile, which is a collection of

cards on the table. We could define two classes, one for hands and one for piles, but there is not much difference between them. So we'll use one class, called `Hand`, for both hands and piles. Here's what the definition looks like:

```
public class Hand extends CardCollection {

    public Hand(String label) {
        super(label);
    }

    public void display() {
        System.out.println(getLabel() + ": ");
        for (int i = 0; i < size(); i++) {
            System.out.println(getCard(i));
        }
        System.out.println();
    }
}
```

Like `Deck`, the `Hand` class extends `CardCollection`. So it inherits methods like `getLabel`, `size`, and `getCard`, which are used in `display`. `Hand` also provides a constructor, which invokes the constructor of `CardCollection`.

In summary, a `Deck` is just like a `CardCollection`, but it provides a different constructor. And a `Hand` is just like a `CardCollection`, but it provides an additional method, `display`.

14.3 Dealing Cards

To begin the game, we need to deal cards to each of the players. And during the game, we need to move cards between hands and piles. If we add the following method to `CardCollection`, it can meet both of these requirements.

```
public void deal(CardCollection that, int n) {
    for (int i = 0; i < n; i++) {
        Card card = popCard();
        that.addCard(card);
    }
}
```

The `deal` method removes cards from the collection it is invoked on, `this`, and adds them to the collection it gets as a parameter, `that`. The second parameter, `n`, is the number of cards to deal. We will use this method to implement `dealAll`, which deals (or moves) all of the remaining cards.

```
public void dealAll(CardCollection that) {
    int n = size();
    deal(that, n);
}
```

At this point we can create a `Deck` and start dealing cards. Here's a simple example that deals five cards to a hand, and deals the rest into a draw pile:

```
Deck deck = new Deck("Deck");
deck.shuffle();

Hand hand = new Hand("Hand");
deck.deal(hand, 5);
hand.display();

Hand drawPile = new Hand("Draw Pile");
deck.dealAll(drawPile);
System.out.printf("Draw Pile has %d cards.\n",
    drawPile.size());
```

Because the deck is shuffled randomly, you should get a different hand each time you run this example. The output will look something like:

```
Hand:
5 of Diamonds
Ace of Hearts
6 of Clubs
6 of Diamonds
2 of Clubs

Draw Pile has 47 cards.
```

If you are a careful reader, you might notice something strange about this example. Take another look at the definition of `deal`. Notice that the first parameter is supposed to be a `CardCollection`. But we invoked it like this:

```
Hand hand = new Hand("Hand");
deck.deal(hand, 5);
```

The argument is a `Hand`, not a `CardCollection`. So why is this example legal?

It's because `Hand` is a subclass of `CardCollection`, so a `Hand` object is also considered to be a `CardCollection` object. If a method expects a `CardCollection`, you can give it a `Hand`, a `Deck`, or a `CardCollection`.

But it doesn't work the other way around: not every `CardCollection` is a `Hand`, so if a method expects a `Hand`, you have to give it a `Hand`, not a `CardCollection` or a `Deck`.

If it seems strange that an object can belong to more than one type, remember that this happens in real life, too. Every cat is also a mammal, and every mammal is also an animal. But not every animal is a mammal, and not every mammal is a cat.

14.4 The Player Class

The `Deck` and `Hand` classes we have defined so far could be used for any card game; we have not yet implemented any of the rules specific to *Crazy Eights*. And that's probably a good thing, since it makes it easy to reuse these classes if we want to make another game in the future.

But now it's time to implement the rules. We'll use two classes: `Player`, which encapsulates player strategy, and `Eights`, which creates and maintains the state of the game. Here is the beginning of the `Player` definition:

```
public class Player {

    private String name;
    private Hand hand;

    public Player(String name) {
        this.name = name;
        this.hand = new Hand(name);
    }
}
```

A `Player` has two `private` attributes: a name and a hand. The constructor takes the player's name as a string and saves it in an instance variable. In this example, we have to use `this` to distinguish between the instance variable and the parameter with the same name.

The primary method that `Player` provides is `play`, which decides which card to discard during each turn:

```
public Card play(Eights eights, Card prev) {
    Card card = searchForMatch(prev);
    if (card == null) {
        card = drawForMatch(eights, prev);
    }
    return card;
}
```

The first parameter is a reference to the `Eights` object that encapsulates the state of the game. We'll need it if we have to draw a new card. The second parameter, `prev`, is the card on top of the discard pile.

Using top-down development, the `play` method invokes two helper methods, `searchForMatch` and `drawForMatch`. The first method looks in the player's hand for a card that matches the previously played card:

```
public Card searchForMatch(Card prev) {
    for (int i = 0; i < hand.size(); i++) {
        Card card = hand.getCard(i);
        if (cardMatches(card, prev)) {
            return hand.popCard(i);
        }
    }
    return null;
}
```

The strategy is pretty simple: the `for` loop searches for the first card that's legal to play and returns it. If there are no cards that match, it returns `null`. And in that case, we have to draw cards until we get a match.

```
public Card drawForMatch(Eights eights, Card prev) {
    while (true) {
        Card card = eights.drawCard();
        System.out.println(name + " draws " + card);
        if (cardMatches(card, prev)) {
            return card;
        }
        hand.addCard(card);
    }
}
```

The `while` loop runs until it finds a match (we'll assume for now that it always does). It uses the `Eights` object to draw a card. If it matches, it returns the card. Otherwise it adds the card to the player's hand and repeats.

Both `searchForMatch` and `drawForMatch` use `cardMatches`, which is a static method, also defined in `Player`. This method is a straightforward translation of the rules of the game:

```
public static boolean cardMatches(Card card1, Card card2) {
    return card1.getSuit() == card2.getSuit()
        || card1.getRank() == card2.getRank()
        || card1.getRank() == 8;
}
```

Finally, `Player` provides a `score` method, which computes penalty points for cards left in a player's hand at the end of the game.

14.5 The Eights Class

In Section 13.2 we introduced top-down development, which is a way of developing programs by identifying high-level goals, like shuffling a deck, and breaking them into smaller problems, like finding the lowest element in an array or swapping two elements.

In this section we present **bottom-up design**, which goes the other way around: first we identify simple pieces we need, then we assemble them into more complex algorithms.

Looking at the rules of *Crazy Eights*, we can identify some of the methods we'll need:

- Create the deck, the players, and the discard and draw piles. Deal the cards and set up the game. (`Eights` constructor)
- Check whether the game is over. (`isDone`)
- If the draw pile is empty, shuffle the discard pile and move the cards into the draw pile. (`reshuffle`)
- Draw a card, reshuffling the discard pile if necessary. (`drawCard`)
- Keep track of whose turn it is, and switch from one player to the next. (`nextPlayer`)
- Display the state of the game, and wait for the user before running the next turn. (`displayState`)

Now we can start implementing the pieces. Here is the beginning of the class definition for `Eights`, which encapsulates the state of the game:

```
public class Eights {  
  
    private Player one;  
    private Player two;  
    private Hand drawPile;  
    private Hand discardPile;  
    private Scanner in;
```

In this version, there are always two players. One of the exercises at the end of the chapter asks you to modify this code to handle more players. The `Eights` class also includes a draw pile, a discard pile, and a `Scanner`, which we will use to prompt the user after each turn.

The constructor for `Eights` initializes the instance variables and deals the cards, similar to Section 14.3. The next piece we'll need is a method that checks whether the game is over. If either hand is empty, we're done:

```
public boolean isDone() {  
    return one.getHand().empty() || two.getHand().empty();  
}
```

When the draw pile is empty, we have to shuffle the discard pile. Here is a method for that:

```
public void reshuffle() {
    Card prev = discardPile.popCard();
    discardPile.dealAll(drawPile);
    discardPile.addCard(prev);
    drawPile.shuffle();
}
```

The first line saves the top card from `discardPile`. The next line transfers the rest of the cards to `drawPile`. Then we put the saved card back into `discardPile` and shuffle `drawPile`. We can use `reshuffle` as part of the `draw` method:

```
public Card drawCard() {
    if (drawPile.empty()) {
        reshuffle();
    }
    return drawPile.popCard();
}
```

The `nextPlayer` method takes the current player as a parameter and returns the player who should go next.

```
public Player nextPlayer(Player current) {
    if (current == one) {
        return two;
    } else {
        return one;
    }
}
```

The last method from our bottom-up design is `displayState`. It displays the hand of each player, the contents of the discard pile, and how many cards are in the draw pile. Finally, it waits for the user to press the Enter key.

Using these pieces, we can write `takeTurn`, which executes one player's turn. It reads the top card off the discard pile and passes it to `player.play`, which we saw in the previous section. The result is the card the player chose, which is added to the discard pile.

```
public void takeTurn(Player player) {
    Card prev = discardPile.lastCard();
    Card next = player.play(this, prev);
    discardPile.addCard(next);

    System.out.println(player.getName() + " plays " + next);
    System.out.println();
}
```

Finally, we use `takeTurn` and the other methods to write `playGame`:

```
public void playGame() {
    Player player = one;

    // keep playing until there's a winner
    while (!isDone()) {
        displayState();
        takeTurn(player);
        player = nextPlayer(player);
    }

    // display the final score
    one.displayScore();
    two.displayScore();
}
```

Done! Notice the result of bottom-up design is similar to top-down: we have a high-level method that calls helper methods. The main difference is the order we used to arrive at this solution.

14.6 Class Relationships

This chapter demonstrates two common relationships between classes:

composition: Instances of one class contain references to instances of another class. For example, an instance of `Eights` contains references to two `Player` objects, two `Hand` objects, and a `Scanner`.

inheritance: One class extends another class. For example, `Hand` extends `CardCollection`, so every instance of `Hand` is also a `CardCollection`.

Composition is also known as a **HAS-A** relationship, as in “`Eights HAS-A Scanner`”. Inheritance is also known as an **IS-A** relationship, as in “a `Hand IS-A CardCollection`”. This vocabulary provides a concise way to talk about an object-oriented design.

There is also a standard way to represent these relationships graphically in UML class diagrams. As we saw in Section 10.7, the UML representation of a class is a box with three sections: the class name, the attributes, and the methods. The latter two sections are optional when showing relationships.

Relationships between classes are represented by arrows: composition arrows have a standard arrow head, and inheritance arrows have a hollow triangle head (usually pointing up). Figure 14.1 shows the classes defined in this chapter and the relationships among them.

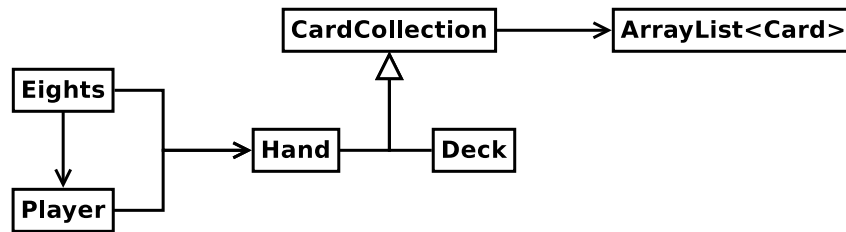

Figure 14.1: UML diagram for the classes in this chapter.

UML is an international standard, so almost any software engineer in the world could look at this diagram and understand our design. And class diagrams are only one of many graphical representations defined in the UML standard.

14.7 Vocabulary

inheritance: The ability to define a new class that has the same instance variables and methods of an existing class.

subclass: A class that inherits from, or extends, an existing class.

superclass: An existing class that is extended by another class.

bottom-up design: A way of developing programs by identifying simple pieces, implementing them, and then assembling them into more complex algorithms.

HAS-A: A relationship between two classes where one class “has” an instance of another class as one of its attributes.

IS-A: A relationship between two classes where one class extends another class; the subclass “is” an instance of the superclass.

14.8 Exercises

The code for this chapter is in the `ch14` directory of `ThinkJavaCode2`. See page xix for instructions on how to download the repository. Before you start the exercises, we recommend that you compile and run the examples.

Exercise 14.1 Design a better strategy for the `Player.play` method. For example, if there are multiple cards you can play, and one of them is an eight, you might want to play the eight.

Think of other ways you can minimize penalty points, such as playing the highest-ranking cards first. Write a new class that extends `Player` and overrides `play` to implement your strategy.

Exercise 14.2 Write a loop that plays the game 100 times and keeps track of how many times each player wins. If you implemented multiple strategies in the previous exercise, you can play them against each other to evaluate which one works best.

Hint: Design a `Genius` class that extends `Player` and overrides the `play` method, and then replace one of the players with a `Genius` object.

Exercise 14.3 One limitation of the program we wrote in this chapter is that it only handles two players. Modify the `Eights` class to create an `ArrayList` of players, and modify `nextPlayer` to select the next player.

Exercise 14.4 When we designed the program for this chapter, we tried to minimize the number of classes. As a result, we ended up with a few awkward

methods. For example, `cardMatches` is a static method in `Player`, but it would be more natural if it were an instance method in `Card`.

The problem is that `Card` is supposed to be useful for any card game, not just *Crazy Eights*. You can solve this problem by adding a new class, `EightsCard`, that extends `Card` and provides a method, `match`, that checks whether two cards match according to the rules of *Crazy Eights*.

At the same time, you could create a new class, `EightsHand`, that extends `Hand` and provides a method, `scoreHand`, that adds up the scores of the cards in the hand. And while you're at it, you could add a method named `scoreCard` to `EightsCard`.

Whether or not you actually make these changes, draw a UML class diagram that shows this alternative object hierarchy.

Appendix A

Tools

The steps for compiling, running, and debugging Java code depend on your development environment and operating system. We avoided putting these details in the main text, because they can be distracting. Instead, we provide this appendix with a brief introduction to DrJava – an **integrated development environment** (IDE) that is helpful for beginners – and other development tools, including Checkstyle for code quality and JUnit for testing.

A.1 Installing DrJava

The easiest way to start programming in Java is to use a website that compiles and runs Java code in the browser. Examples include <https://repl.it/>, <https://trinket.io/>, <https://jdoodle.com/>, and others.

If you are unable to install software on your computer (which is often the case in public schools and Internet cafés), you can use these online development environments for almost everything in this book.

But if you want to compile and run Java programs on your own computer, you will need:

- The **Java Development Kit** (JDK), which includes the compiler, the **Java Virtual Machine** (JVM) that interprets the compiled byte code, and other tools such as Javadoc.

- A **text editor** such as Atom, Notepad++, or Sublime Text, and/or an IDE such as DrJava, Eclipse, jGrasp, or NetBeans.

The JDK we recommend is Java SE (Standard Edition), which Oracle makes available for free. The IDE we recommend is DrJava, which is an open-source development environment written in Java (see Figure A.1).

To install the JDK, search the web for “download JDK” which should take you to Oracle’s website. Scroll down to “Java Platform, Standard Edition” and click the download button under JDK. Then accept the license agreement and select the installer for your operating system. Don’t forget to run the installer after you download it!

To install DrJava, visit <http://drjava.org/> and download the **JAR** file. We recommend that you save it to your Desktop or another convenient location. Simply double-click the JAR file to run DrJava. Refer to the DrJava documentation (<http://drjava.org/docs/quickstart/>) for more details.

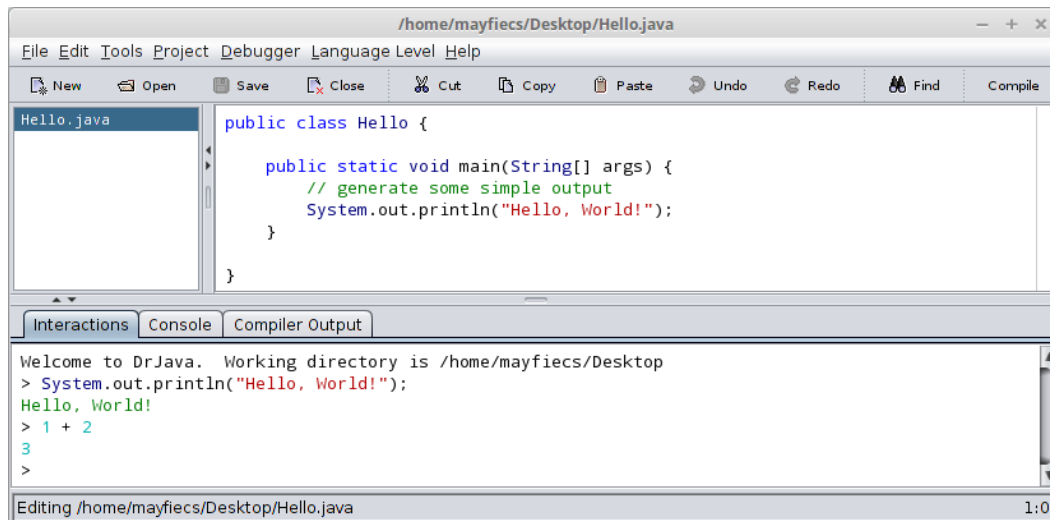

Figure A.1: Screenshot of DrJava editing the hello world program.

When running DrJava for the first time, we recommend you change three settings from the `Edit > Preferences` menu under `Miscellaneous`: set the `Indent Level` to 4, check the `Automatically Close Block Comments` box, and uncheck the `Keep Emacs-style Backup Files` box.

A.2 DrJava Interactions

One of the most useful features of DrJava is the “Interactions Pane” at the bottom of the window. It provides the ability to try out code quickly, without having to write a class definition and save/compile/run the program. Figure A.2 shows an example.

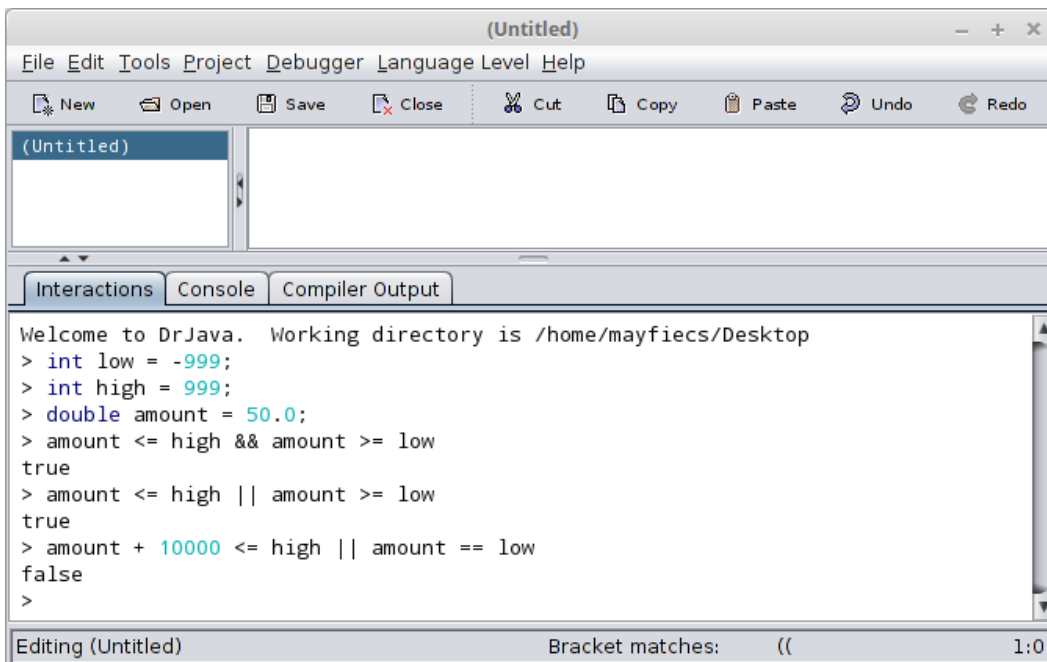

Figure A.2: Screenshot of the Interactions Pane in DrJava.

There is one subtle detail to note when using the Interactions feature. If you don’t end an expression (or statement) with a semicolon, DrJava automatically displays its value. Notice in Figure A.2 how the variable declarations end with semicolons, but the logic expressions in the following lines do not. This feature saves you from having to type `System.out.println` every time.

What’s nice about this feature is that you don’t have to create a new class, declare a `main` method, write arbitrary expressions inside `System.out.println` statements, save the source file, and get all of your code to compile in advance. Also, you can press the up/down arrows on the keyboard to repeat previous commands and experiment with incremental differences.

A.3 Command-Line Interface

One of the most powerful and useful skills you can learn is how to use the **command-line interface**, also called the “terminal”. The command line is a direct interface to the operating system. It allows you to run programs, manage files and directories, and monitor system resources. Many advanced tools, both for software development and general-purpose computing, are available only at the command line.

There are many good tutorials online for learning the command line for your operating system; just search the web for “command line tutorial”. On Unix systems like Linux and OS X, you can get started with just four commands: change the working directory (`cd`), list directory contents (`ls`), compile Java programs (`javac`), and run Java programs (`java`).

Figure A.3 shows an example where the `Hello.java` source file is stored in the `Desktop` directory. After changing to that location and listing the files, we use the `javac` command to compile `Hello.java`. Running `ls` again, we see that the compiler generated a new file, `Hello.class`, which contains the byte code. We run the program using the `java` command, which displays the output on the following line.

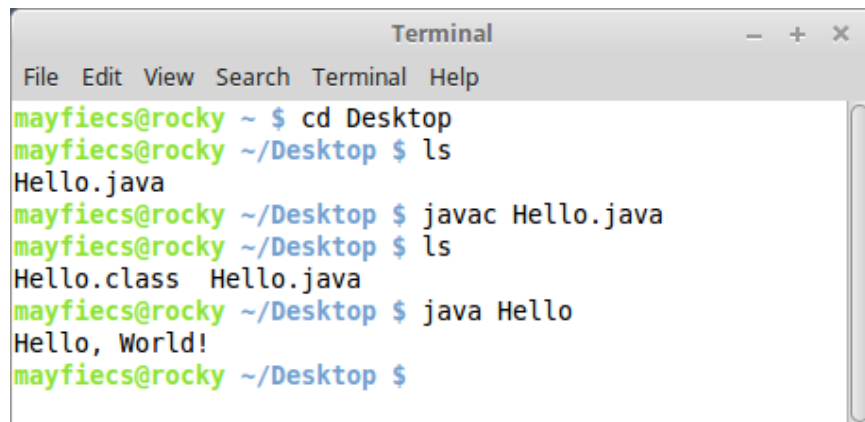
A screenshot of a terminal window titled "Terminal" with standard window controls (minimize, maximize, close). The terminal shows a series of commands and their outputs. The user is at a prompt "mayfiecs@rocky ~" and enters "cd Desktop". The prompt changes to "mayfiecs@rocky ~/Desktop". Then "ls" is entered, showing "Hello.java". Next, "javac Hello.java" is entered, and the prompt changes to "mayfiecs@rocky ~/Desktop". Another "ls" command is entered, showing "Hello.class Hello.java". Finally, "java Hello" is entered, and the output "Hello, World!" is displayed. The terminal ends with the prompt "mayfiecs@rocky ~/Desktop \$".

```
Terminal
File Edit View Search Terminal Help
mayfiecs@rocky ~ $ cd Desktop
mayfiecs@rocky ~/Desktop $ ls
Hello.java
mayfiecs@rocky ~/Desktop $ javac Hello.java
mayfiecs@rocky ~/Desktop $ ls
Hello.class Hello.java
mayfiecs@rocky ~/Desktop $ java Hello
Hello, World!
mayfiecs@rocky ~/Desktop $
```

Figure A.3: Compiling and running `Hello.java` from the command line.

Note that the `javac` command requires a *filename* (or multiple source files separated by spaces), whereas the `java` command requires a single *class name*. If you use DrJava, it runs these commands for you behind the scenes and displays the output in the Interactions Pane.

Taking time to learn this efficient and elegant way of interacting with the operating system will make you more productive. People who don't use the command line don't know what they're missing.

A.4 Command-Line Testing

As described in Section 1.9, it's more effective to program and debug your code little by little than to attempt writing everything all at once. And after you've completed programming an algorithm, it's important to test that it works correctly on a variety of inputs.

Throughout the book, we illustrate techniques for testing your programs. Most, if not all, testing is based on a simple idea: does the program do what we expect it to do? For simple programs, it's not difficult to run them several times and see what happens. But at some point, you will get tired of typing the same test cases over and over.

We can automate the process of entering input and comparing “expected output” with “actual output” using the command line. The basic idea is to store the test cases in plain text files and trick Java into thinking they are coming from the keyboard. Here are step-by-step instructions:

1. Make sure you can compile and run the `Convert.java` example in the `ch03` directory of `ThinkJavaCode2`. (See page xix for instructions on how to download the repository.)
2. In the same directory as `Convert.java`, create a plain text file named `test.in` (“in” is for input). Enter the following line and save the file:

```
193.04
```

3. Create a second plain text file named `test.exp` (“exp” is for expected). Enter the following line and save the file:

```
193.04 cm = 6 ft, 4 in
```

4. Open a terminal, and change to the directory with these files. Run the following command to test the program:

```
java Convert < test.in > test.out
```

On the command line, `<` and `>` are **redirection operators**. The first one redirects the contents of `test.in` to `System.in`, as if it were entered from the keyboard. The second one redirects the contents of `System.out` to a new file `test.out`, much like a screen capture. In other words, the `test.out` file contains the output of your program.

By the way, it's perfectly okay to compile your programs in DrJava (or some other environment) and run them from the command line. Knowing both techniques allows you to use the right tool for the job.

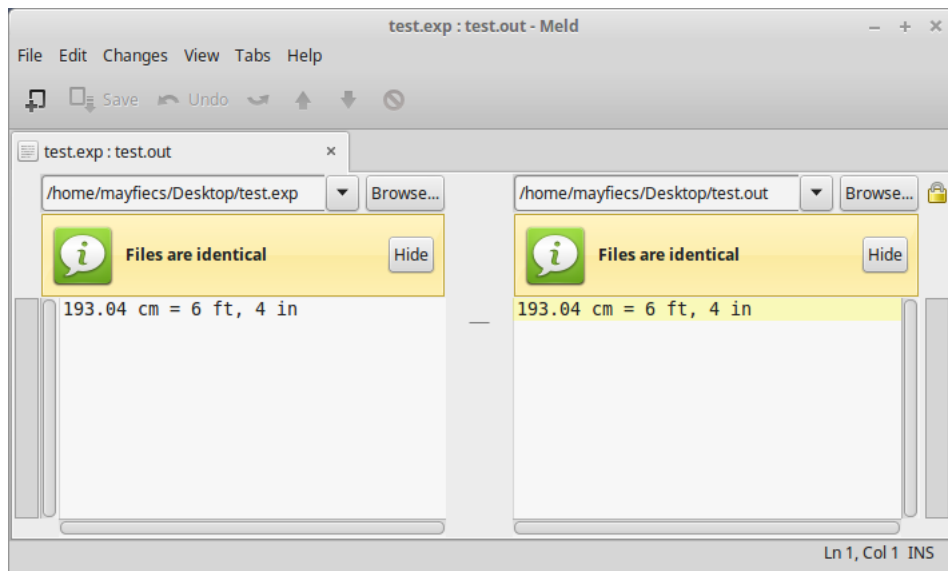

Figure A.4: Using `meld` to compare expected output with the actual output.

At this point, we just need to compare the contents `test.out` with `test.exp`. If the files are the same, then the program outputted what we expected it to output. If not, then we found a bug, and we can use the output to begin debugging our program. Fortunately, there's a simple way to compare files on the command line:

```
diff test.exp test.out
```

The `diff` utility summarizes the differences between two files. If there are no differences, then it displays nothing, which in our case is what we want. If the expected output differs from the actual output, then we need to continue debugging. Usually the program is at fault, and `diff` provides some insight

about what is broken. But there's also a chance that we have a correct program and the expected output is wrong.

Interpreting the results from `diff` can be confusing, but fortunately there are many graphical tools that show the differences between two files. For example, on Windows you can install `WinMerge`, on Mac you can use `opendiff` (which comes with Xcode), and on Linux there's `meld`, shown in Figure A.4.

Regardless of what tool you use, the goal is the same. Debug your program until the actual output is *identical* to the expected output.

A.5 Running Checkstyle

Checkstyle is a command-line tool that can be used to determine if your source code follows a set of style rules. It also checks for common programming mistakes, such as class and method design problems.

You can download the latest version as a JAR file from <https://checkstyle.sourceforge.io/>. To run Checkstyle, move (or copy) the JAR file to the same directory as your program. Open a terminal in that location, and run the following command:

```
java -jar checkstyle-**-all.jar -c /google_checks.xml *.java
```

The `*` characters are **wildcards** that match whatever version of Checkstyle you have and whatever Java source files are present. The output indicates the file and line number of each problem. This example refers to a method beginning on line 93, column 5 of `Hello.java`:

```
Hello.java:93:5: Missing a Javadoc comment
```

The file `/google_checks.xml` is inside the JAR file and represents most of Google's style rules. You can alternatively use `/sun_checks.xml` or provide your own configuration file. See Checkstyle's website for more information.

If you apply Checkstyle to your source code often, you will likely internalize good style habits over time. But there are limits to what automatic style checkers can do. In particular, they can't evaluate the *quality* of your comments, the *meaning* of your variable names, or the *structure* of your algorithms.

Good comments make it easier for experienced developers to identify errors in your code. Good variable names communicate the intent of your program and how the data is organized. And good programs are designed to be efficient and demonstrably correct.

A.6 Tracing with a Debugger

A great way to visualize the flow of execution, including how parameters and arguments work, is to use a **debugger**. Most debuggers make it possible to:

1. Set a **breakpoint**, a line where you want the program to pause.
2. Step through the code one line at a time and watch what it does.
3. Check the values of variables and see when and how they change.

For example, open any program in DrJava and move the cursor to the first line of `main`. Press `Ctrl+B` to toggle a breakpoint on the current line; it should now be highlighted in red. Press `Ctrl+Shift+D` to turn on Debug Mode; a new pane should appear at the bottom of the window. These commands are also available from the **Debugger** menu, in case you forget the shortcut keys.

When you run the program, execution pauses at the first breakpoint. The debug pane displays the **call stack**, with the current method on top of the stack, as shown in Figure A.5. You might be surprised to see how many methods were called before the `main` method!

To the right are several buttons that allow you to step through the code at your own pace. You can also press **Automatic Trace** to watch DrJava run your code one line at a time.

Using a debugger is like having the computer proofread your code out loud. When the program is paused, you can examine (or even change) the value of any variable using the Interactions Pane.

Tracing allows you to follow the flow of execution and see how data pass from one method to another. You might expect the code do one thing, but then the debugger shows it doing something else. At that moment, you gain insight about what may be wrong with the code.

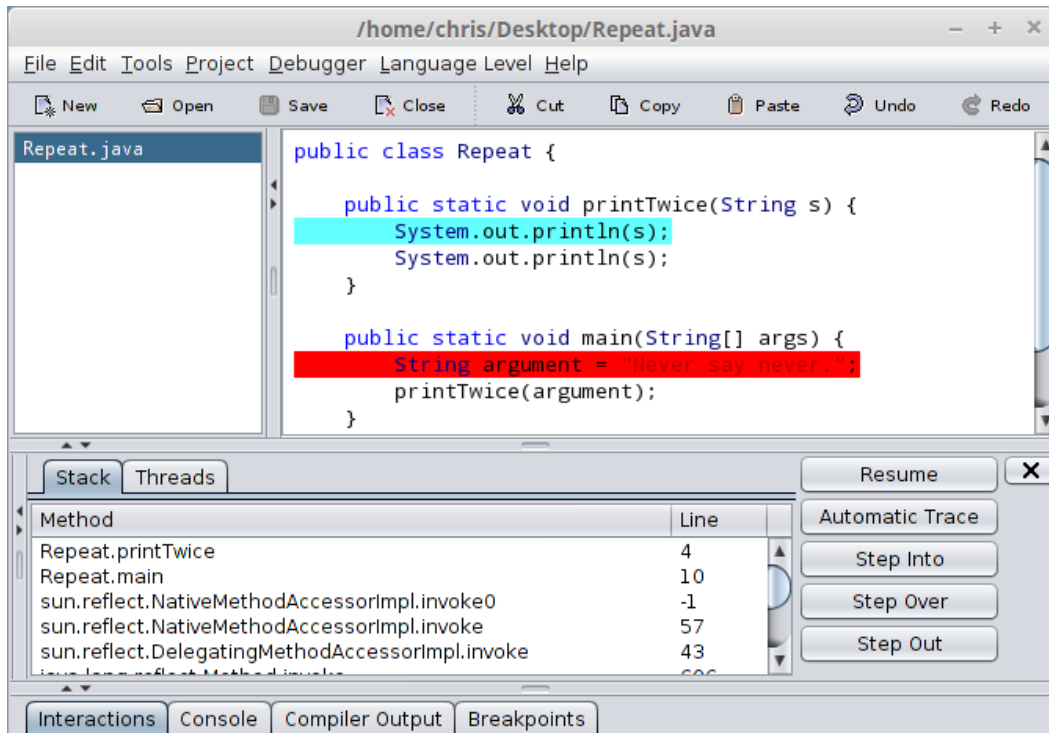

Figure A.5: Screenshot of the DrJava debugger. Execution is currently paused on the first line of `printTwice`. There is a breakpoint on the first line of `main`.

You can edit your code while debugging it, but we don't recommend it. If you add or delete multiple lines of code while the program is paused, the results can be confusing.

See <http://drjava.org/docs/user/ch09.html> for more information about using the debugger feature of DrJava.

A.7 Testing with JUnit

When beginners start writing methods, they usually test them by invoking them from `main` and checking the results by hand. Writing code like this can get repetitive, but there are tools to make it easier. For cases where we know the right answer, we can do better by writing **unit tests**.

For example, to test `fibonacci` from Section 8.4, we could write:

```
public static void main(String[] args) {
    if (fibonacci(1) != 1) {
        System.err.println("fibonacci(1) is incorrect");
    }
    if (fibonacci(2) != 1) {
        System.err.println("fibonacci(2) is incorrect");
    }
    if (fibonacci(3) != 2) {
        System.err.println("fibonacci(3) is incorrect");
    }
}
```

This test code is self-explanatory, but it's longer than it needs to be and it doesn't scale very well. In addition, the error messages provide limited information. Using a unit test framework addresses these and other issues.

JUnit is a common testing tool for Java programs (see <https://junit.org/>). To use it, you have to create a test class that contains test methods. If the name of your class is `Class`, the name of the test class is `ClassTest`. And if there is a method in `Class` named `method`, there should be a method in `TestClass` named `testMethod`.

For example, suppose that the `fibonacci` method belongs to a class named `Series`. Here is the corresponding JUnit test class and test method:

```
import junit.framework.TestCase;

public class SeriesTest extends TestCase {

    public void testFibonacci() {
        assertEquals(1, Series.fibonacci(1));
        assertEquals(1, Series.fibonacci(2));
        assertEquals(2, Series.fibonacci(3));
    }
}
```

This example uses the keyword `extends`, which indicates that the new class, `SeriesTest` is based on an existing class, `TestCase`. The `TestCase` class is imported from the package `junit.framework`.

Many development environments can generate test classes and test methods automatically. In DrJava, you can select **New JUnit Test Case** from the File menu to generate an empty test class.

`assertEquals` is provided by the `TestCase` class. It takes two arguments and checks whether they are equal. If so, it does nothing; otherwise it displays a detailed error message. The first argument is the “expected value”, which we consider correct, and the second argument is the “actual value” we want to check. If they are not equal, the test fails.

Using `assertEquals` is more concise than writing your own `if` statements and `System.err` messages. JUnit provides additional assert methods, such as `assertNull`, `assertSame`, and `assertTrue`, that can be used to design a variety of tests.

To run JUnit directly from DrJava, click the **Test** button on the toolbar. If all your test methods pass, you will see a green bar in the lower-right corner. Otherwise, DrJava will take you directly to the first assertion that failed.

A.8 Vocabulary

IDE: An “integrated development environment” that includes tools for editing, compiling, and debugging programs.

JDK: The “Java Development Kit” that contains the compiler, Javadoc, and other tools.

JVM: The “Java Virtual Machine” that interprets the compiled byte code.

text editor: A program that edits plain text files, the format used by most programming languages.

JAR: A “Java Archive”, which is essentially a ZIP file containing classes and other resources.

command-line interface: A means of interacting with the computer by issuing commands in the form of successive lines of text.

redirection operator: A command-line feature that substitutes `System.in` and/or `System.out` with a plain text file.

wildcard: A command-line feature that allows you to specify a pattern of filenames using the * character.

debugger: A tool that allows you to run one statement at a time and see the contents of variables.

breakpoint: A line of code where the debugger will pause a running program.

call stack: The history of method calls and where to resume execution after each method returns.

unit test: Code that exercises a single method of a program, testing for correctness and/or efficiency.

Appendix B

Javadoc

Java programs have three different types of comments:

1. **End-of-line comments** (`//`), which generally contain short phrases that explain specific lines of code.
2. **Multi-line comments** (`/*`), which are typically only used for copyright statements at the top of the file.
3. **Documentation comments** (`/**`), which describe in sufficient detail what each class and method does.

End-of-line and multi-line comments are written primarily for yourself. They help you remember specific details about your source code. Documentation comments, on the other hand, are written for others. They explain how to use your classes and methods in other programs.

A nice feature of the Java language is the ability to embed documentation in the source code itself. That way, you can write it as you go, and as things change, it is easier to keep the documentation consistent with the code.

You can extract documentation from your source code, and generate well-formatted HTML pages, using a tool called **Javadoc**. This tool is included with the Java compiler, and it is widely used. In fact, the official documentation for the Java library (see <https://thinkjava.org/apidoc>) is generated by Javadoc.

B.1 Reading Documentation

As an example, let's look at the documentation for `Scanner`, a class we first used in Section 3.2. You can find the documentation quickly by doing a web search for “Java Scanner”. Figure B.1 shows a screenshot of the page.

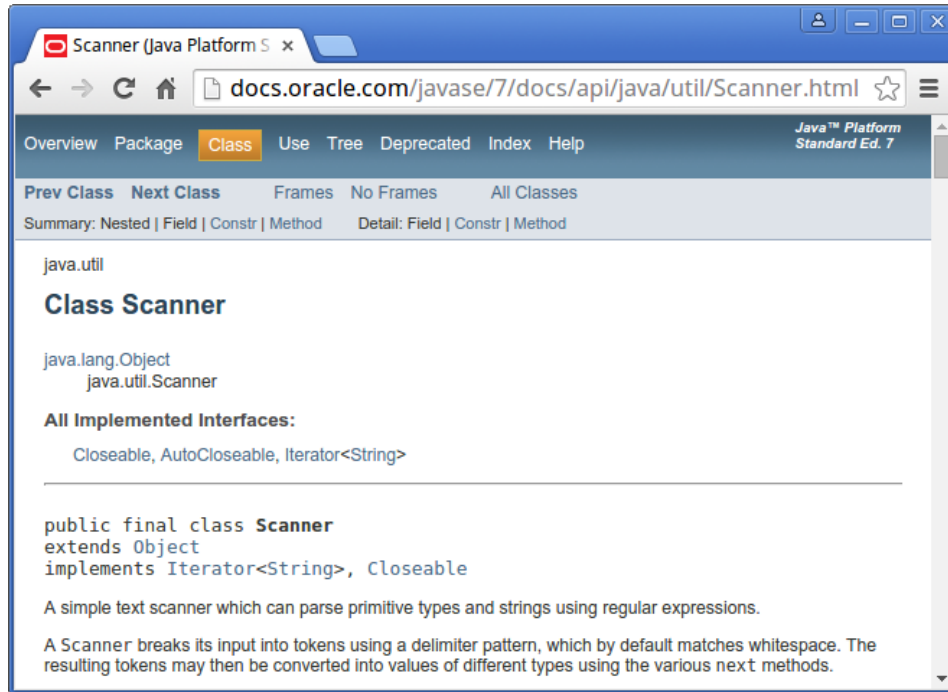

Figure B.1: Screenshot of the documentation for `Scanner`.

Documentation for other classes uses a similar format. The first line is the package that contains the class, such as `java.util`. The second line is the name of the class. The “Implemented Interfaces” section lists some of the functionality a `Scanner` has.

The next section of the documentation is a narrative that explains the purpose of the class and includes examples of how to use it. This text can be difficult to read, because it may use terms you have not yet learned. But the examples are often very useful. A good way to get started with a new class is to paste the examples into a test file and see if you can compile and run them.

One of the examples shows how you can use a `Scanner` to read input from a `String` instead of `System.in`:

```
String input = "1 fish 2 fish red fish blue fish";
Scanner s = new Scanner(input);
```

After the narrative, code examples, and some other details, you will find the following tables:

Constructor summary: Ways of creating, or “constructing”, a `Scanner`.

Method summary: The list of methods that the `Scanner` class provides.

Constructor detail: More information about how to create a `Scanner`.

Method detail: More information about each method.

For example, here is the summary information for `nextInt`:

```
public int nextInt()
Scans the next token of the input as an int.
```

The first line is the method’s **signature**, which specifies the name of the method, its parameters (none), and what type it returns (`int`). The next line is a short description of what it does.

The “Method detail” explains more:

```
public int nextInt()
Scans the next token of the input as an int.
```

An invocation of this method of the form `nextInt()` behaves in exactly the same way as the invocation `nextInt(radix)`, where `radix` is the default radix of this scanner.

Returns:

the `int` scanned from the input

Throws:

`InputMismatchException` - if the next token does not match the `Integer` regular expression, or is out of range

`NoSuchElementException` - if input is exhausted

`IllegalStateException` - if this scanner is closed

The “Returns” section describes the result when the method succeeds. In contrast, the “Throws” section describes possible errors and exceptions that may occur. Exceptions are said to be “thrown”, like a referee throwing a flag, or like a toddler throwing a fit.

It might take you some time to get comfortable reading documentation and learning which parts to ignore. But it’s worth the effort. Knowing what’s available in the library helps you avoid reinventing the wheel. And a little bit of documentation can save you a lot of debugging.

B.2 Writing Documentation

As you benefit from reading good documentation, you should “pay it forward” by writing good documentation.

Javadoc scans your source files looking for documentation comments, also known as “Javadoc comments”. They begin with `/**` (two stars) and end with `*/` (one star). Anything in between is considered part of the documentation.

Here’s a class definition with two Javadoc comments, one for the `Goodbye` class and one for the `main` method:

```
/**
 * Example program that demonstrates print vs println.
 */
public class Goodbye {

    /**
     * Prints a greeting.
     */
    public static void main(String[] args) {
        System.out.print("Goodbye, "); // note the space
        System.out.println("cruel world");
    }
}
```

The class comment explains the purpose of the class. The method comment explains what the method does.

Notice that this example also has an end-of-line comment (`///`). In general, these comments are short phrases that help explain complex parts of a program. They are intended for other programmers reading and maintaining the source code.

In contrast, Javadoc comments are longer, usually complete sentences. They explain what each method does, but they omit details about how the method works. And they are intended for people who will use the methods without looking at the source code.

Appropriate comments and documentation are essential for making source code readable. And remember that the person most likely to read your code in the future, and appreciate good documentation, is you.

B.3 Javadoc Tags

It's generally a good idea to document each class and method, so that other programmers can understand what they do without having to read the code.

To organize the documentation into sections, Javadoc supports optional **tags** that begin with the at sign (`@`). For example, we can use `@author` and `@version` to provide information about the class.

```
/**
 * Utility class for extracting digits from integers.
 *
 * @author Chris Mayfield
 * @version 1.0
 */
public class DigitUtil {
```

Documentation comments should begin with a **description** of the class or method, followed by the tags. These two sections are separated by a blank line (not counting the `*`).

For methods, we can use `@param` and `@return` to provide information about parameters and return values.

```
/**
 * Tests whether x is a single digit integer.
 *
 * @param x the integer to test
 * @return true if x has one digit, false otherwise
 */
public static boolean isSingleDigit(int x) {
```

Figure B.2 shows part of the resulting HTML page generated by Javadoc. Notice the relationship between the Javadoc comment (in the source code) and the resulting documentation (in the HTML page).

isSingleDigit
<pre>public static boolean isSingleDigit(int x)</pre>
Tests whether x is a single digit integer.
Parameters:
x - the integer to test
Returns:
true if x has one digit, false otherwise

Figure B.2: HTML documentation for `isSingleDigit`.

When writing parameter comments, do not include a hyphen (-) after the `@param` tag. Otherwise, you will have two hyphens in the resulting HTML documentation.

Notice also that the `@return` tag should not specify the type of the method. Comments like `@return boolean` are not useful, because you already know the return type from the method's signature.

Methods with multiple parameters should have separate `@param` tags that describe each one. Void methods should have no `@return` tag, since they do not return a value. Each tag should be on its own line in the source code.

B.4 Example Source File

Now let's take a look at a more complete example. The code for this section is in the `appb` directory of `ThinkJavaCode2`. See page xix for instructions on how to download the repository.

Professional-grade source files often begin with a copyright statement. This text spans multiple lines, but it is not part of the documentation. So we use a multi-line comment (`/*`). Our example source file, `Convert.java`, includes the MIT License (<https://opensource.org/licenses/MIT>).

```
/*
 * Copyright (c) 2019 Allen Downey and Chris Mayfield
 *
 * Permission is hereby granted, free of charge, to any person obtaining a copy
 * of this software and associated documentation files (the "Software"), to deal
 * in the Software without restriction, including without limitation the rights
 * to use, copy, modify, merge, publish, distribute, sublicense, and/or sell
 * copies of the Software, and to permit persons to whom the Software is
 * furnished to do so, subject to the following conditions:
 *
 * The above copyright notice and this permission notice shall be included in
 * all copies or substantial portions of the Software.
 *
 * THE SOFTWARE IS PROVIDED "AS IS", WITHOUT WARRANTY OF ANY KIND, EXPRESS OR
 * IMPLIED, INCLUDING BUT NOT LIMITED TO THE WARRANTIES OF MERCHANTABILITY,
 * FITNESS FOR A PARTICULAR PURPOSE AND NONINFRINGEMENT. IN NO EVENT SHALL THE
 * AUTHORS OR COPYRIGHT HOLDERS BE LIABLE FOR ANY CLAIM, DAMAGES OR OTHER
 * LIABILITY, WHETHER IN AN ACTION OF CONTRACT, TORT OR OTHERWISE, ARISING FROM,
 * OUT OF OR IN CONNECTION WITH THE SOFTWARE OR THE USE OR OTHER DEALINGS IN THE
 * SOFTWARE.
 */
```

Import statements generally follow the copyright text. After that, we can define the class itself and begin writing the documentation (`/**`).

```
import java.util.Scanner;

/**
 * Methods for converting to/from the metric system.
 *
 * @author Allen Downey
 * @author Chris Mayfield
 * @version 6.1.5
 */
public class Convert {
```

A common mistake that beginners make is to put `import` statements between the documentation and the `public class` line. Doing so separates the documentation from the class itself. To avoid this issue, always make the end of the comment (the `*/`) “touch” the word `public`.

This class has two constants and three methods. The constants are self-explanatory, so there is no need to write documentation for them.

```
public static final double CM_PER_INCH = 2.54;

public static final int IN_PER_FOOT = 12;
```

The methods, on the other hand, could use some explanation. Each documentation comment includes a description, followed by a blank line, followed by a `@param` tag for each parameter, followed by a `@return` tag.

```
/**
 * Converts a measurement in centimeters to inches.
 *
 * @param cm length in centimeters
 * @return length in inches
 */
public static double toImperial(double cm) {
    return cm / CM_PER_INCH;
}

/**
 * Converts a length in feet and inches to centimeters.
 *
 * @param feet how many feet
 * @param inches how many inches
 * @return length in centimeters
 */
public static double toMetric(int feet, int inches) {
    int total = feet * IN_PER_FOOT + inches;
    return total * CM_PER_INCH;
}
```

The main method has a similar documentation comment, except there is no `@return` tag since the method is `void`.

```
/**
 * Tests the conversion methods.
 *
 * @param args command-line arguments
 */
public static void main(String[] args) {
    double cm, result;
    int feet, inches;
    Scanner in = new Scanner(System.in);

    // test the Imperial conversion
    System.out.print("Exactly how many cm? ");
    cm = in.nextDouble();
    result = toImperial(cm);
    System.out.printf("That's %.2f inches\n", result);
    System.out.println();

    // test the Metric conversion
    System.out.print("Now how many feet? ");
    feet = in.nextInt();
    System.out.print("And how many inches? ");
    inches = in.nextInt();
    result = toMetric(feet, inches);
    System.out.printf("That's %.2f cm\n", result);
}
```

Here are two ways you can run the Javadoc tool on this example program:

1. From the command line, go to the location for `Convert.java`. The `-d` option of `javadoc` indicates where to generate the HTML files.

```
javadoc -d doc Convert.java
```

2. From DrJava, click the **Javadoc** button on the toolbar. The IDE will then prompt you for a location to generate the HTML files.

For more examples of what you can do with Javadoc comments, see the source code of any Java library class (e.g., `Scanner.java`). Section 10.6 explains how to find the source files for the Java library on your computer.

B.5 Vocabulary

documentation: Comments that describe the technical operation of a class or method.

Javadoc: A tool that reads Java source code and generates documentation in HTML format.

signature: The first line of a method that defines its name, return type, and parameters.

tag: A label that begins with an at sign (@) and is used by Javadoc to organize documentation into sections.

description: The first line of a documentation comment that explains what the class/method does.

Appendix C

Graphics

The Java library includes a simple package for drawing 2D graphics, called `java.awt`. **AWT** stands for “Abstract Window Toolkit”. We are only going to scratch the surface of graphics programming. You can read more about it in the Java tutorials at <https://thinkjava.org/java2d>.

C.1 Creating Graphics

There are several ways to create graphics in Java; the simplest way is to use `java.awt.Canvas` and `java.awt.Graphics`. A `Canvas` is a blank rectangular area of the screen onto which the application can draw. The `Graphics` class provides basic drawing methods such as `drawLine`, `drawRect`, and `drawString`.

Here is an example program that draws a circle using the `fillOval` method:

```
import java.awt.Canvas;
import java.awt.Graphics;
import javax.swing.JFrame;

public class Drawing extends Canvas {
```

```
public static void main(String[] args) {
    JFrame frame = new JFrame("My Drawing");
    Canvas canvas = new Drawing();
    canvas.setSize(400, 400);
    frame.add(canvas);
    frame.pack();
    frame.setVisible(true);
}

public void paint(Graphics g) {
    g.fillOval(100, 100, 200, 200);
}
}
```

The `Drawing` class extends `Canvas`, so it has all the methods provided by `Canvas`, including `setSize`. You can read about the other methods in the documentation, which you can find by doing a web search for “Java Canvas”.

In the `main` method, we:

1. Create a `JFrame` object, which is the window that will contain the canvas.
2. Create a `Drawing` object (which is the canvas), set its width and height, and add it to the frame.
3. Pack the frame (resize it) to fit the canvas, and display it on the screen.

Once the frame is visible, the `paint` method is called whenever the canvas needs to be drawn; for example, when the window is moved or resized. The application doesn't end after the `main` method returns; instead, it waits for the `JFrame` to close. If you run this code, you should see a black circle on a gray background.

C.2 Graphics Methods

You are probably used to Cartesian **coordinates**, where x and y values can be positive or negative. In contrast, Java uses a coordinate system where the

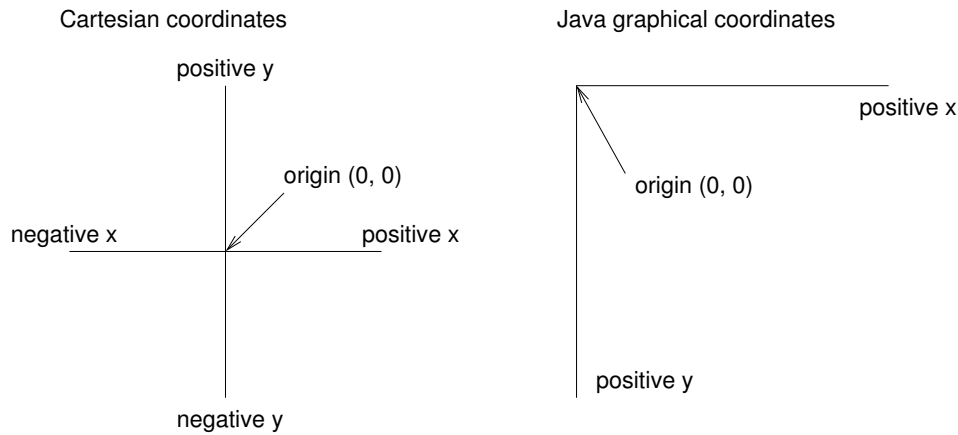

Figure C.1: Diagram of the difference between Cartesian coordinates and Java graphical coordinates.

origin is in the upper-left corner. That way, x and y can always be positive integers. Figure C.1 shows these coordinate systems side-by-side.

Graphical coordinates are measured in **pixels**; each pixel corresponds to a dot on the screen.

To draw on the canvas, you invoke methods on a **Graphics** object. You don't have to create the **Graphics** object; it gets created when you create the **Canvas**, and it gets passed as an argument to **paint**.

The previous example used `fillOval`, which has the following signature:

```
/**
 * Fills an oval bounded by the specified rectangle with
 * the current color.
 */
public void fillOval(int x, int y, int width, int height)
```

The four parameters specify a **bounding box**, which is the rectangle in which the oval is drawn. x and y specify the location of the upper-left corner of the bounding box. The bounding box itself is not drawn (see Figure C.2).

To choose the color of a shape, invoke `setColor` on the **Graphics** object:

```
g.setColor(Color.red);
```

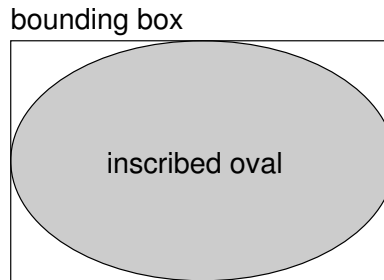

Figure C.2: Diagram of an oval inside its bounding box.

The `setColor` method determines the color of everything that gets drawn afterward. `Color.red` is a constant provided by the `Color` class; to use it you have to `import java.awt.Color`. Other colors include:

```
black      blue      cyan      darkGray  gray      green
lightGray  magenta  orange    pink      white     yellow
```

You can create your own colors by specifying the red, green, and blue (**RGB**) components. For example:

```
Color purple = new Color(128, 0, 128);
```

Each value is an integer in the range 0 (darkest) to 255 (lightest). The color (0, 0, 0) is black, and (255, 255, 255) is white.

You can set the background color of the `Canvas` by invoking `setBackground`:

```
canvas.setBackground(Color.white);
```

C.3 Example Drawing

Suppose we want to draw a “Hidden Mickey”, which is an icon that represents Mickey Mouse (see https://en.wikipedia.org/wiki/Hidden_Mickey). We can use the oval we just drew as the face, and then add two ears. To make the code more readable, let’s use `Rectangle` objects to represent bounding boxes.

Here’s a method that takes a `Rectangle` and invokes `fillOval`:

```
public void boxOval(Graphics g, Rectangle bb) {
    g.fillOval(bb.x, bb.y, bb.width, bb.height);
}
```

And here's a method that draws Mickey Mouse:

```
public void mickey(Graphics g, Rectangle bb) {
    boxOval(g, bb);

    int dx = bb.width / 2;
    int dy = bb.height / 2;
    Rectangle half = new Rectangle(bb.x, bb.y, dx, dy);

    half.translate(-dx / 2, -dy / 2);
    boxOval(g, half);

    half.translate(dx * 2, 0);
    boxOval(g, half);
}
```

The first line draws the face. The next three lines create a smaller rectangle for the ears. We `translate` the rectangle up and left for the first ear, then to the right for the second ear. The result is shown in Figure C.3.

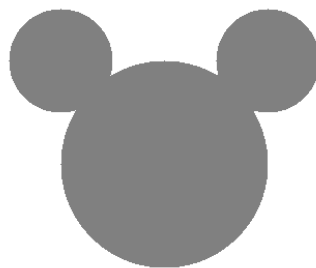

Figure C.3: A “Hidden Mickey” drawn using Java graphics.

You can read more about `Rectangle` and `translate` in Chapter 10. See the exercises at the end of this appendix for more example drawings.

C.4 Vocabulary

AWT: The “Abstract Window Toolkit”, a Java package for creating graphical user interfaces.

coordinate: A value that specifies a location in a 2D graphical window.

pixel: The unit in which coordinates are measured.

bounding box: A way to specify the coordinates of a rectangular area.

RGB: A color model based on adding red, green, and blue light.

C.5 Exercises

The code for this chapter is in the `apcc` directory of `ThinkJavaCode2`. See page xix for instructions on how to download the repository. Before you start the exercises, we recommend that you compile and run the examples.

Exercise C.1 Draw the flag of Japan: a red circle on a white background that is wider than it is tall.

Exercise C.2 Modify `Mickey.java` to draw ears on the ears, and ears on those ears, and more ears all the way down until the smallest ears are only 3 pixels wide. The result should look like “Mickey Moose”, shown in Figure C.4. *Hint:* You should only have to add or modify a few lines of code.

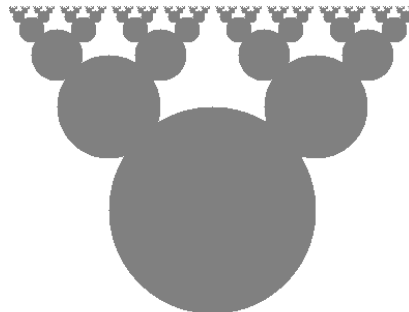
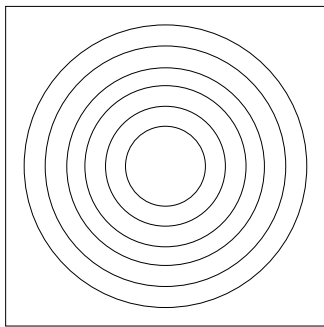

Figure C.4: A recursive shape we call “Mickey Moose”.

Exercise C.3 In this exercise, you will draw “Moiré patterns” that seem to shift around as you move. For an explanation of what is going on, see https://en.wikipedia.org/wiki/Moire_pattern.

1. Open `Moire.java` and read the `paint` method. Draw a sketch of what you expect it to do. Now run it. Did you get what you expected?
2. Modify the program so that the space between the circles is larger or smaller. See what happens to the image.
3. Modify the program so that the circles are drawn in the center of the screen and concentric, as in Figure C.5 (left). The distance between the circles should be small enough that the Moiré interference is apparent.

concentric circles



radial Moire pattern

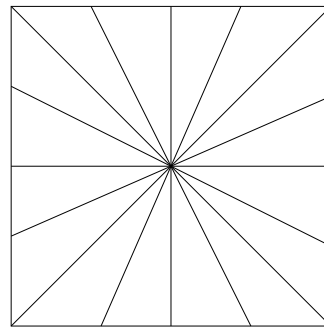

Figure C.5: Graphical patterns that can exhibit Moiré interference.

4. Write a method named `radial` that draws a radial set of line segments as shown in Figure C.5 (right), but they should be close enough together to create a Moiré pattern.
5. Just about any kind of graphical pattern can generate Moiré-like interference patterns. Play around and see what you can create.

Appendix D

Debugging

Although there are debugging suggestions throughout the book, we thought it would be useful to say more in an appendix. If you are having a hard time debugging, you might want to review this appendix from time to time.

The best debugging strategy depends on what kind of error you have:

- **Compile-time errors** indicate that there is something wrong with the syntax of the program. Example: omitting the semicolon at the end of a statement.
- **Run-time errors** are produced if something goes wrong while the program is running. Example: an infinite recursion eventually causes a `StackOverflowError`.
- **Logic errors** cause the program to do the wrong thing. Example: an expression may not be evaluated in the order you expect.

The following sections are organized by error type; some techniques are useful for more than one type.

D.1 Compile-Time Errors

The best kind of debugging is the kind you don't have to do because you avoid making errors in the first place. Incremental development, which we presented

in Section 4.9, can help. The key is to start with a working program and add small amounts of code at a time. When there is an error, you will have a pretty good idea where it is.

Nevertheless, you might find yourself in one of the following situations. For each situation, we have some suggestions about how to proceed.

The compiler is spewing error messages.

If the compiler reports 100 error messages, that doesn't mean there are 100 errors in your program. When the compiler encounters an error, it often gets thrown off track for a while. It tries to recover and pick up again after the first error, but sometimes it reports spurious errors.

Only the first error message is truly reliable. We suggest that you only fix one error at a time, and then recompile the program. You may find that one semicolon or brace "fixes" 100 errors.

I'm getting a weird compiler message, and it won't go away.

First of all, read the error message carefully. It may be written in terse jargon, but often there is a carefully hidden kernel of information.

If nothing else, the message will tell you where in the program the problem occurred. Actually, it tells you where the compiler was when it noticed a problem, which is not necessarily where the error is. Use the information the compiler gives you as a guideline, but if you don't see an error where the compiler is pointing, broaden the search.

Generally the error will be prior to the location of the error message, but there are cases where it will be somewhere else entirely. For example, if you get an error message at a method invocation, the actual error may be in the method definition itself.

If you don't find the error quickly, take a breath and look more broadly at the entire program. Make sure the program is indented properly; that makes it easier to spot syntax errors.

Now, start looking for common syntax errors:

1. Check that all parentheses and brackets are balanced and properly nested. All method definitions should be nested within a class definition. All program statements should be within a method definition.
2. Remember that uppercase letters are not the same as lowercase letters.
3. Check for semicolons at the end of statements (and no semicolons after curly braces).
4. Make sure that any strings in the code have matching quotation marks. Make sure that you use double quotes for strings and single quotes for characters.
5. For each assignment statement, make sure that the type on the left is the same as the type on the right. Make sure that the expression on the left is a variable name or something else that you can assign a value to (like an element of an array).
6. For each method invocation, make sure that the arguments you provide are in the right order and have the right type, and that the object you are invoking the method on is the right type.
7. If you are invoking a value method, make sure you are doing something with the result. If you are invoking a void method, make sure you are *not* trying to do something with the result.
8. If you are invoking an instance method, make sure you are invoking it on an object with the right type. If you are invoking a static method from outside the class where it is defined, make sure you specify the class name (using dot notation).
9. Inside an instance method you can refer to the instance variables without specifying an object. If you try that in a static method – with or without `this` – you get a message like “non-static variable x cannot be referenced from a static context.”

If nothing works, move on to the next section...

I can't get my program to compile no matter what I do.

If the compiler says there is an error and you don't see it, that might be because you and the compiler are not looking at the same code. Check your development environment to make sure the program you are editing is the program the compiler is compiling.

This situation is often the result of having multiple copies of the same program. You might be editing one version of the file, but compiling a different version.

If you are not sure, try putting an obvious and deliberate syntax error right at the beginning of the program. Now compile again. If the compiler doesn't find the new error, there is probably something wrong with the way you set up the development environment.

If you have examined the code thoroughly, and you are sure the compiler is compiling the right source file, it is time for desperate measures: **debugging by bisection**.

- Make a backup of the file you are working on. If you are working on `Bob.java`, make a copy called `Bob.java.old`.
- Delete about half the code from `Bob.java`. Try compiling again.
 - If the program compiles now, you know the error is in the code you deleted. Bring back about half of what you deleted and repeat.
 - If the program still doesn't compile, the error must be in the code that remains. Delete about half of the remaining code and repeat.
- Once you have found and fixed the error, start bringing back the code you deleted, a little bit at a time.

This process is ugly, but it goes faster than you might think, and it is very reliable. It works for other programming languages too!

I did what the compiler told me to do, but it still doesn't work.

Some error messages come with tidbits of advice, like “class `Golfer` must be declared abstract. It does not define `compareTo(java.lang.Object)` from

interface java.lang.Comparable.” It sounds like the compiler is telling you to declare `Golfer` as an `abstract` class, and if you are reading this book, you probably don’t know what that is or how to do it.

Fortunately, the compiler is wrong. The solution in this case is to make sure `Golfer` has a method called `compareTo` that takes an `Object` as a parameter.

Don’t let the compiler lead you by the nose. Error messages give you evidence that something is wrong, but the remedies they suggest are unreliable.

D.2 Run-Time Errors

It’s not always clear what causes a run-time error, but you can often figure things out by adding print statements to your program.

My program hangs.

If a program stops and seems to be doing nothing, we say it is “hanging”. Often that means it is caught in an infinite loop or an infinite recursion.

- If there is a particular loop that you suspect is the problem, add a print statement immediately before the loop that says “entering the loop” and another immediately after that says “exiting the loop”.

Run the program. If you get the first message and not the second, you know where the program is getting stuck. Go to the section titled “Infinite loop”.

- Most of the time an infinite recursion will cause the program to run for a while and then produce a `StackOverflowError`. If that happens, go to the section titled “Infinite recursion”.

If you are not getting a `StackOverflowError`, but you suspect there is a problem with a recursive method, you can still use the techniques in the infinite recursion section.

- If neither of the previous suggestions helps, you might not understand the flow of execution in your program. Go to the section titled “Flow of execution”.

Infinite Loop

If you think you have an infinite loop and you know which loop it is, add a print statement at the end of the loop that displays the values of the variables in the condition, and the value of the condition.

For example:

```
while (x > 0 && y < 0) {
    // do something to x
    // do something to y

    System.out.println("x: " + x);
    System.out.println("y: " + y);
    System.out.println("condition: " + (x > 0 && y < 0));
}
```

Now when you run the program you see three lines of output for each time through the loop. The last time through the loop, the condition should be **false**. If the loop keeps going, you will see the values of `x` and `y`, and you might figure out why they are not getting updated correctly.

Infinite Recursion

Most of the time, an infinite recursion will cause the program to throw a `StackOverflowError`. But if the program is slow, it may take a long time to fill the stack.

If you know which method is causing an infinite recursion, check that there is a base case. There should be some condition that makes the method return without making a recursive invocation. If not, you need to rethink the algorithm and identify a base case.

If there is a base case, but the program doesn't seem to be reaching it, add a print statement at the beginning of the method that displays the parameters. Now when you run the program you see a few lines of output every time the method is invoked, and you can see the values of the parameters. If the parameters are not moving toward the base case, you might see why not.

Flow of Execution

If you are not sure how the flow of execution is moving through your program, add print statements to the beginning of each method with a message like “entering method foo”, where `foo` is the name of the method. Now when you run the program, it displays a trace of each method as it is invoked.

You can also display the arguments each method receives. When you run the program, check whether the values are reasonable, and check for one of the most common errors – providing arguments in the wrong order.

When I run the program I get an exception.

When an exception occurs, Java displays a message that includes the name of the exception, the line of the program where the exception occurred, and a “stack trace”. The stack trace includes the method that was running, the method that invoked it, the method that invoked that one, and so on.

The first step is to examine the place in the program where the error occurred and see if you can figure out what happened.

NullPointerException: You tried to access an instance variable or invoke a method on an object that is currently `null`. You should figure out which variable is `null` and then figure out how it got to be that way.

Remember that when you declare a variable with an array type, its elements are initially `null` until you assign a value to them. For example, this code causes a `NullPointerException`:

```
int[] array = new Point[5];
System.out.println(array[0].x);
```

ArrayIndexOutOfBoundsException: The index you are using to access an array is either negative or greater than `array.length - 1`. If you can find the site where the problem is, add a print statement immediately before it to display the value of the index and the length of the array. Is the array the right size? Is the index the right value?

Now work your way backwards through the program and see where the array and the index come from. Find the nearest assignment statement

and see if it is doing the right thing. If either one is a parameter, go to the place where the method is invoked and see where the values are coming from.

StackOverflowError: See “Infinite recursion” on page 286.

FileNotFoundException: This means Java didn’t find the file it was looking for. If you are using a project-based development environment like Eclipse, you might have to import the file into the project. Otherwise make sure the file exists and that the path is correct. This problem depends on your file system, so it can be hard to track down.

ArithmeticException: Something went wrong during an arithmetic operation; for example, division by zero.

I added so many print statements I get inundated with output.

One of the problems with using print statements for debugging is that you can end up buried in output. There are two ways to proceed: either simplify the output, or simplify the program.

To simplify the output, you can remove or comment out print statements that aren’t helping, or combine them, or format the output so it is easier to understand. As you develop a program, you should write code to generate concise, informative traces of what the program is doing.

To simplify the program, scale down the problem the program is working on. For example, if you are sorting an array, sort a *small* array. If the program takes input from the user, give it the simplest input that causes the error.

Also, clean up the code. Remove unnecessary or experimental parts, and reorganize the program to make it easier to read. For example, if you suspect that the error is in a deeply-nested part of the program, rewrite that part with a simpler structure. If you suspect a large method, split it into smaller methods and test them separately.

The process of finding the minimal test case often leads you to the bug. For example, if you find that a program works when the array has an even number

of elements, but not when it has an odd number, that gives you a clue about what is going on.

Reorganizing the program can help you find subtle bugs. If you make a change that you think doesn't affect the program, and it does, that can tip you off.

D.3 Logic Errors

My program doesn't work.

Logic errors are hard to find because the compiler and interpreter provide no information about what is wrong. Only you know what the program is supposed to do, and only you know that it isn't doing it.

The first step is to make a connection between the code and the behavior you get. You need a hypothesis about what the program is actually doing. Here are some questions to ask yourself:

- Is there something the program was supposed to do, but doesn't seem to be happening? Find the section of the code that performs that function, and make sure it is executing when you think it should. See "Flow of execution" on page 287.
- Is something happening that shouldn't? Find code in your program that performs that function, and see if it is executing when it shouldn't.
- Is a section of code producing an unexpected effect? Make sure you understand the code, especially if it invokes methods in the Java library. Read the documentation for those methods, and try them out with simple test cases. They might not do what you think they do.

To program, you need a mental model of what your code does. If it doesn't do what you expect, the problem might not actually be the program; it might be in your head.

The best way to correct your mental model is to break the program into components (usually the classes and methods) and test them independently. Once you find the discrepancy between your model and reality, you can solve the problem.

Here are some common logic errors to check for:

- Remember that integer division always rounds toward zero. If you want fractions, use `double`. More generally, use integers for countable things and floating-point numbers for measurable things.
- Floating-point numbers are only approximate, so don't rely on them to be perfectly accurate. You should probably never use the `==` operator with `doubles`. Instead of writing `if (d == 1.23)`, do something like `if (Math.abs(d - 1.23) < .000001)`.
- When you apply the equality operator (`==`) to objects, it checks whether they are identical. If you meant to check equivalence, you should use the `equals` method instead.
- By default for user-defined types, `equals` checks identity. If you want a different notion of equivalence, you have to override it.
- Inheritance can lead to subtle logic errors, because you can run inherited code without realizing it. See “Flow of execution” on page 287.

I've got a big hairy expression and it doesn't do what I expect.

Writing complex expressions is fine as long as they are readable, but they can be hard to debug. It is often a good idea to break a complex expression into a series of assignments to temporary variables.

```
rect.setLocation(rect.getLocation().translate(
    -rect.getWidth(), -rect.getHeight()));
```

This example can be rewritten as:

```
int dx = -rect.getWidth();
int dy = -rect.getHeight();
Point location = rect.getLocation();
Point newLocation = location.translate(dx, dy);
rect.setLocation(newLocation);
```

The second version is easier to read, partly because the variable names provide additional documentation. It's also easier to debug, because you can check the types of the temporary variables and display their values.

Another problem that can occur with big expressions is that the order of operations may not be what you expect. For example, to evaluate $\frac{x}{2\pi}$, you might write:

```
double y = x / 2 * Math.PI;
```

That is not correct, because multiplication and division have the same precedence, and they are evaluated from left to right. This code computes $\frac{x}{2}\pi$.

If you are not sure of the order of operations, check the documentation, or use parentheses to make it explicit.

```
double y = x / (2 * Math.PI);
```

This version is correct, and more readable for other people who haven't memorized the order of operations.

My method doesn't return what I expect.

If you have a return statement with a complex expression, you don't have a chance to display the value before returning.

```
public Rectangle intersection(Rectangle a, Rectangle b) {  
    return new Rectangle(  
        Math.min(a.x, b.x), Math.min(a.y, b.y),  
        Math.max(a.x + a.width, b.x + b.width)  
            - Math.min(a.x, b.x),  
        Math.max(a.y + a.height, b.y + b.height)  
            - Math.min(a.y, b.y));  
}
```

Instead of writing everything in one statement, use temporary variables:

```
public Rectangle intersection(Rectangle a, Rectangle b) {  
    int x1 = Math.min(a.x, b.x);  
    int y1 = Math.min(a.y, b.y);  
    int x2 = Math.max(a.x + a.width, b.x + b.width);  
    int y2 = Math.max(a.y + a.height, b.y + b.height);  
    Rectangle rect = new Rectangle(x1, y1, x2 - x1, y2 - y1);  
    return rect;  
}
```

Now you have the opportunity to display any of the intermediate variables before returning. And by reusing `x1` and `y1`, you made the code smaller, too.

My print statement isn't doing anything.

If you use the `println` method, the output is displayed immediately, but if you use `print` (at least in some environments), the output gets stored without being displayed until the next newline. If the program terminates without displaying a newline, you may never see the stored output. If you suspect that this is happening, change some or all of the `print` statements to `println`.

I'm really, really stuck and I need help.

First, get away from the computer for a few minutes. Computers emit waves that affect the brain, causing the following symptoms:

- Frustration and rage.
- Superstitious beliefs (“the computer hates me”) and magical thinking (“the program only works when I wear my hat backwards”).
- Sour grapes (“this program is lame anyway”).

If you suffer from any of these symptoms, get up and go for a walk. When you are calm, think about the program. What is it doing? What are possible causes of that behavior? When was the last time you had a working program, and what did you do next?

Sometimes it just takes time to find a bug. People often find bugs when they let their mind wander. Good places to find bugs are buses, showers, and bed.

No, I really need help.

It happens. Even the best programmers get stuck. Sometimes you need another pair of eyes.

Before you bring someone else in, make sure you have tried the techniques described in this appendix.

Your program should be as simple as possible, and you should be working on the smallest input that causes the error. You should have print statements in the appropriate places (and the output they produce should be comprehensible). You should understand the problem well enough to describe it concisely.

When you bring someone in to help, give them the information they need:

- What kind of bug is it? Compile-time, run-time, or logic?
- What was the last thing you did before this error occurred? What were the last lines of code that you wrote, or what is the test case that fails?
- If the bug occurs at compile time or run time, what is the error message, and what part of the program does it indicate?
- What have you tried, and what have you learned?

By the time you explain the problem to someone, you might see the answer. This phenomenon is so common that some people recommend a debugging technique called “rubber ducking”. Here’s how it works:

1. Buy a standard-issue rubber duck.
2. When you are really stuck on a problem, put the rubber duck on the desk in front of you and say, “Rubber duck, I am stuck on a problem. Here’s what’s happening...”
3. Explain the problem to the rubber duck.
4. Discover the solution.
5. Thank the rubber duck.

We’re not kidding, it works! See https://en.wikipedia.org/wiki/Rubber_duck_debugging.

I found the bug!

When you find the bug, it is usually obvious how to fix it. But not always. Sometimes what seems to be a bug is really an indication that you don't understand the program, or there is an error in your algorithm. In these cases, you might have to rethink the algorithm, or adjust your mental model. Take some time away from the computer to think, work through test cases by hand, or draw diagrams to represent the computation.

After you fix the bug, don't just start in making new errors. Take a minute to think about what kind of bug it was, why you made the error, how the error manifested itself, and what you could have done to find it faster. Next time you see something similar, you will be able to find the bug more quickly. Or even better, you will learn to avoid that type of bug for good.

Appendix E

Extras

This appendix contains previous sections of the book. We chose to remove them from this edition, because they were not essential to meet the corresponding chapter's goals. However, you may still find this material useful.

E.1 Unreachable Code

Sometimes it is convenient to write multiple `return` statements, for example, one in each branch of a conditional:

```
public static double absoluteValue(double x) {
    if (x < 0) {
        return -x;
    } else {
        return x;
    }
}
```

Since these `return` statements are in a conditional statement, only one will be executed. As soon as either of them executes, the method terminates without executing any more statements.

Code that appears after a `return` statement (in the same block), or any place else where it can never be executed, is called **dead code**. The compiler will

give you an “unreachable statement” error if part of your code is dead. For example, this method contains two lines of dead code:

```
public static double absoluteValue(double x) {
    if (x < 0) {
        return -x;
        System.out.println("This line is dead."); // error
    } else {
        return x;
    }
    System.out.println("So is this one."); // error
}
```

If you put `return` statements inside a conditional statement, you have to make sure that *every possible path* through the method reaches a `return` statement. The compiler will let you know if that’s not the case. For example, the following method is incomplete:

```
public static double absoluteValue(double x) {
    if (x < 0) {
        return -x;
    } else if (x > 0) {
        return x;
    }
    // error: missing return statement
}
```

When `x` is 0, neither condition is true, so the method ends without hitting a return statement. The error message in this case might be something like “missing return statement”, which is confusing since there are already two.

Compiler errors like “unreachable statement” and “missing return statement” often indicate a problem with your algorithm, not the code. In the previous example, `if (x > 0)` is unnecessary because `x` will always be positive or zero at that point. Changing that `else if` to an `else` resolves the error.

dead code: Part of a program that can never be executed, often because it appears after a `return` statement.

E.2 Method Composition

Once you define a method, you can use it to build other methods. For example, suppose someone gave you two points – the center of a circle and a point on the perimeter – and asked for the area of the circle.

Let's say the center point is stored in the variables `xc` and `yc`, and the perimeter point is in `xp` and `yp`. The first step is to find the radius of the circle, which is the distance between the two points. Fortunately, we have a method that does just that.

```
double radius = distance(xc, yc, xp, yp);
```

The second step is to find the area of a circle with that radius. We have a method for that computation too.

```
double area = calculateArea(radius);
```

Putting everything together in a new method, we get:

```
public static double circleArea
    (double xc, double yc, double xp, double yp) {
    double radius = distance(xc, yc, xp, yp);
    double area = calculateArea(radius);
    return area;
}
```

Temporary variables like `radius` and `area` are useful for development and debugging, but once the program is working we can make it more concise by composing the method calls:

```
public static double circleArea
    (double xc, double yc, double xp, double yp) {
    return calculateArea(distance(xc, yc, xp, yp));
}
```

This example demonstrates a process known as **functional decomposition**. We broke a complex computation into simple methods, tested the methods in isolation, and then composed the methods to perform the final computation.

functional decomposition: A process for breaking down a complex computation into simple methods, then composing the methods to perform the computation.

E.3 Overloading Methods

You might have noticed that `circleArea` and `calculateArea` perform similar functions. They both find the area of a circle, but they take different parameters. For `calculateArea`, we have to provide the radius; for `circleArea` we provide two points.

If two methods do the same thing, it is natural to give them the same name. Having more than one method with the same name is called **overloading**, and it is legal in Java as long as each version of the method takes different parameters. So we could rename `circleArea` to `calculateArea`:

```
public static double calculateArea
    (double xc, double yc, double xp, double yp) {
    return calculateArea(distance(xc, yc, xp, yp));
}
```

When you invoke an overloaded method, Java knows which version you want by looking at the arguments that you provide.

- For `calculateArea(3.0)`, Java uses the original `calculateArea` method that takes a `double` as an argument and interprets it as the radius.
- For `calculateArea(1.0, 2.0, 4.0, 6.0)`, Java uses the new version of `calculateArea` (renamed from `circleArea`), which interprets the arguments as two points.

In fact, the second version of `calculateArea` invokes the first version (after invoking the `distance` method).

Many Java library methods are overloaded, meaning that there are different versions that accept different numbers or types of parameters. For example, there are variants of `print` and `println` that accept a single parameter of any data type. In the `Math` class, there is a version of `abs` that works on `doubles`, and there is also a version for `ints`.

Although overloading is a useful feature, it should be used with caution. You might get yourself nicely confused if you are trying to debug one version of a method while accidentally invoking a different one.

overload: To define more than one method with the same name but with different parameters.

E.4 Generating Tables

Before computers were readily available, people had to calculate logarithms, sines and cosines, and other common mathematical functions by hand. To make that easier, there were books of tables where you could look up values of various functions. Creating these tables by hand was slow and boring, and the results were often full of errors.

When computers appeared on the scene, one of the initial reactions was: “This is great! We can use a computer to generate the tables, so there will be no errors.” That turned out to be true (mostly), but shortsighted. Not much later, computers were so pervasive that printed tables became obsolete.

Even so, for some operations, computers use tables of values to get an approximate answer, and then perform computations to improve the approximation. In some cases, there have been errors in the underlying tables, most famously in the table the original Intel Pentium used to perform floating-point division (see https://en.wikipedia.org/wiki/Pentium_FDIV_bug).

Although a “log table” is not as useful as it once was, it still makes a good example of iteration. The following loop displays a table with a sequence of values in the left column and their logarithms in the right column:

```
int i = 1;
while (i < 10) {
    double x = i;
    System.out.println(x + "    " + Math.log(x));
    i = i + 1;
}
```

The output of this program is:

```
1.0    0.0
2.0    0.6931471805599453
3.0    1.0986122886681098
4.0    1.3862943611198906
5.0    1.6094379124341003
6.0    1.791759469228055
7.0    1.9459101490553132
8.0    2.0794415416798357
9.0    2.1972245773362196
```

`Math.log` computes natural logarithms, that is, logarithms base e . For computer science applications, we often want logarithms with respect to base 2. To compute them, we can apply this equation:

$$\log_2 x = \frac{\log_e x}{\log_e 2}$$

We can modify the loop as follows:

```
int i = 1;
while (i < 10) {
    double x = i;
    System.out.println(x + "    " + Math.log(x) / Math.log(2));
    i = i + 1;
}
```

And here are the results:

```
1.0    0.0
2.0    1.0
3.0    1.5849625007211563
4.0    2.0
5.0    2.321928094887362
6.0    2.584962500721156
7.0    2.807354922057604
8.0    3.0
9.0    3.1699250014423126
```

Each time through the loop, we add one to `x`, so the result is an arithmetic sequence. If we multiply `x` by something instead, we get a geometric sequence:

```
final double LOG2 = Math.log(2);
int i = 1;
while (i < 100) {
    double x = i;
    System.out.println(x + "    " + Math.log(x) / LOG2);
    i = i * 2;
}
```

The first line stores `Math.log(2)` in a `final` variable to avoid computing that value over and over again. The last line multiplies `x` by 2. The result is:

```
1.0  0.0
2.0  1.0
4.0  2.0
8.0  3.0
16.0 4.0
32.0 5.0
64.0 6.0
```

This table shows the powers of two and their logarithms, base 2. Log tables may not be useful anymore, but for computer scientists, knowing the powers of two helps a lot!

E.5 The do-while Loop

The `while` and `for` statements are **pretest loops**; that is, they test the condition first and at the beginning of each pass through the loop.

Java also provides a **posttest loop**: the `do-while` statement. This type of loop is useful when you need to run the body of the loop at least once.

For example, in Section 5.9 we used the `return` statement to avoid reading invalid input from the user. We can use a `do-while` loop to keep reading input until it's valid:

```
Scanner in = new Scanner(System.in);
boolean okay;
do {
    System.out.print("Enter a number: ");
    if (in.hasNextDouble()) {
        okay = true;
    } else {
        okay = false;
        String word = in.next();
        System.err.println(word + " is not a number");
    }
} while (!okay);
double x = in.nextDouble();
```

Although this code looks complicated, it is essentially only three steps:

1. Display a prompt.
2. Check the input; if invalid, display an error and start over.
3. Read the input.

The code uses a flag variable, `okay`, to indicate whether we need to repeat the loop body. If `hasNextDouble()` returns `false`, we consume the invalid input by calling `next()`. We then display an error message via `System.err`. The loop terminates when `hasNextDouble()` return `true`.

pretest loop: A loop that tests the condition before each iteration.

posttest loop: A loop that tests the condition after each iteration.

E.6 Break and Continue

Sometimes neither a pretest nor a posttest loop will provide exactly what you need. In the previous example, the “test” needed to happen in the middle of the loop. As a result, we used a flag variable and a nested `if-else` statement.

A simpler way to solve this problem is to use a `break` statement. When a program reaches a `break` statement, it exits the current loop.

```
Scanner in = new Scanner(System.in);
while (true) {
    System.out.print("Enter a number: ");
    if (in.hasNextDouble()) {
        break;
    }
    String word = in.next();
    System.err.println(word + " is not a number");
}
double x = in.nextDouble();
```

Using `true` as a conditional in a `while` loop is an idiom that means “loop forever”, or in this case “loop until you get to a `break` statement.”

In addition to the `break` statement, which exits the loop, Java provides a `continue` statement that moves on to the next iteration. For example, the

following code reads integers from the keyboard and computes a running total. The `continue` statement causes the program to skip over any negative values.

```
Scanner in = new Scanner(System.in);
int x = -1;
int sum = 0;
while (x != 0) {
    x = in.nextInt();
    if (x <= 0) {
        continue;
    }
    System.out.println("Adding " + x);
    sum += x;
}
```

Although `break` and `continue` statements give you more control of the loop execution, they can make code difficult to understand. Use them sparingly.

E.7 Modifier Methods

In the previous section, the `add` method did not modify the parameters `t1` or `t2`. Instead, it created and returned a new `Time` object.

Alternatively, we could have written a method like this:

```
public void increment(double seconds) {
    this.second += seconds;

    // carry extra seconds
    this.minute += this.second / 60;
    this.second = this.second % 60;

    // carry extra minutes
    this.hour += this.minute / 60;
    this.minute = this.minute % 60;
}
```

The `increment` method modifies an existing `Time` object. It doesn't create a new one, and it doesn't return anything.

Methods like `increment` are called **modifier** methods. They are usually void, but sometimes they return a reference to the object they modify.

In contrast, methods like `add` are called **pure** methods, because:

- They don't modify the parameters.
- They don't have any other "side effects", like printing.
- The return value only depends on the parameters, not on any other data.

Modifiers can be more efficient because they don't create new objects. But they can also be error-prone. Especially when objects are aliased, the effects of modifiers can be confusing.

If a class provides only getters and pure methods (no setters or modifiers), then the objects will be immutable. Working with immutable objects can be more difficult at first, but they can save you from long hours of debugging.

modifier method: A method that changes the state (instance variables) of an object.

pure method: A method that depends only on its parameters (including the implicit parameter `this`) and no other data.

E.8 Recursive Search

Another way to implement binary search is with a recursive method. We take `low` and `high` as parameters, add a base case, and turn steps 3 and 4 into recursive invocations.

```
public static int binarySearch(Card[] cards, Card target,
                               int low, int high) {
    if (high < low) {
        return -1;
    }
    int mid = (low + high) / 2;           // step 1
    int comp = cards[mid].compareTo(target);

    if (comp == 0) {                     // step 2
        return mid;
    } else if (comp < 0) {               // step 3
        return binarySearch(cards, target, mid + 1, high);
    } else {                             // step 4
        return binarySearch(cards, target, low, mid - 1);
    }
}
```

Instead of a `while` loop, we have an `if` statement to terminate the recursion. If `high` is less than `low`, there are no cards between them, and we conclude that the card is not in the array.

Two common errors in recursive methods are (1) forgetting to include a base case, and (2) writing the recursive call so that the base case is never reached. Either error causes infinite recursion and a `StackOverflowError`.

Index

Symbols

() parentheses, 26
; semicolon, 4, 27
= assignment operator, 18
== equals operator, 71, 192
[] square brackets, 108
% remainder operator, 42
<> angle brackets, 227
{ } curly braces, 4, 73

A

abecedarian, 105
accessor, 189
accumulator, 114, 122
addition
 integer, 22
 string, 25
 time, 194
address, 33, 46, 191
algorithm, 10, 13
alias, 112, 122
aliasing, 222
allocate, 108, 122
anagram, 125
and operator, 77
angle brackets, 227
Append.java, 178
args, 152

argument, 54, 59, 65
ArithmeticException, 28, 288
array, 108, 121
 2D, 215
 copying, 111
 element, 109
 index, 109
 length, 112
 of cards, 217
 of objects, 208
 of strings, 203
 printing, 110
ArrayIndexOutOfBoundsException,
 110, 287
ArrayList, 227, 236
Arrays class, 111, 112
assignment, 18, 30, 71
attribute, 168, 179
automatic conversion, 24, 41, 55, 72
AWT, 167, 273, 278

B

base case, 130, 140
BigInteger, 156
binary, 135, 141
binary search, 211, 214
block, 72, 84
Boole, George, 71

- boolean, 71, 80, 84
- bottom-up design, 244, 249
- bounding box, 275, 278
- brackets
 - angle, 227
 - curly, 4
 - square, 108
- branch, 72, 84
- break, 302
- breakpoint, 258, 262
- bug, 10, 13
- byte code, 6, 13
- C**
- call stack, 130, 258, 262
- camel case, 52
- Canvas, 273
- Card, 202
- CardCollection, 236
- case-sensitive, 4, 18, 52, 101
- chaining, 74, 84
- char, 7, 95
- Character, 151, 154
- charAt, 95
- Checkstyle, 257
- class, 4, 12, 196
 - Canvas, 273
 - Card, 202
 - CardCollection, 236
 - Deck, 217
 - definition, 183
 - Eights, 245
 - Graphics, 273
 - Hand, 240
 - JFrame, 274
 - Math, 58
 - Pile, 227
 - Player, 242
 - Point, 167
 - Rectangle, 170
 - relationships, 247
 - Scanner, 34
 - System, 33
 - Time, 184
 - utility, 34
 - wrapper, 151
- class diagram, 174, 179, 225, 248
- class variable, 205, 214
- client, 188, 197
- CodingBat, 138
- collection, 227, 231
- Color, 275
- command-line interface, 152, 254, 261, 271
- comment, 12, 84
 - documentation, 263, 266
 - end-of-line, 4, 263
 - multi-line, 263
- compareTo, 101, 207
- comparison operator, 71
- compile, 5, 13, 282
- compile-time error, 27, 30, 281
- complete ordering, 206
- composition, 59, 65, 247, 297
- computer science, 10, 13
- concatenate, 25, 30, 161
- conditional statement, 72, 84
- constant, 38, 47
- constructor, 185, 197, 203, 217, 222
 - value, 186
- continue, 302
- Convert.java, 43, 269
- coordinate, 167, 274, 278
- countdown, 127
- counter, 116
- CPU, 2

Crazy Eights, 235

D

De Morgan's laws, 78, 84
dead code, 295, 296
debugger, 258, 262
debugging, 10, 13, 281
 by bisection, 284
 experimental, 11
 rubber duck, 293
Deck, 217
declaration, 17, 30, 168
decrement, 91, 103
degrees, 58
dependent, 189
description, 267, 272
design process, 62, 157, 161, 220, 244
deterministic, 115, 122
diagram
 class, 174, 225, 248
 memory, 20, 99, 112, 147, 168, 186, 193, 204, 217
 stack, 57, 129, 132, 137
divisible, 43
division
 floating-point, 299
 integer, 22, 24
do-while, 301
documentation, 44, 174, 264, 272
 Javadoc comments, 266
 Javadoc tags, 267
dot notation, 168, 179
Double, 151
double, 23
doubloon, 105
Doubloon.java, 120
DrJava, 251

E

Echo.java, 35
efficiency, 117, 163, 178, 211, 221, 231, 237
Eights, 245
element, 108, 109, 121
empty array, 153, 161
empty string, 98, 103
encapsulate, 157, 161
encapsulation, 165, 171
 and generalization, 157
encode, 202, 214
enhanced for loop, 118, 122
equals, 100, 192, 193
equivalent, 192, 197, 206
error
 compile-time, 27, 281
 logic, 29, 281, 289
 message, 11, 27, 282
 rounding, 24
 run-time, 28, 281
 syntax, 283
escape sequence, 9, 13, 95
exception, 28, 281, 287
 Arithmetic, 28
 ArrayIndexOutOfBoundsException, 110
 InputMismatch, 82
 MissingFormatArgument, 40
 NegativeArraySize, 108
 NullPointerException, 149, 154, 209
 NumberFormatException, 152
 StackOverflow, 130, 305
 StringIndexOutOfBoundsException, 97, 155
executable, 5, 13
experimental debugging, 11
expression, 22, 30, 59, 79
 big and hairy, 290

extends, 238, 239
extract digits, 43

F

factorial, 130, 141, 162
fibonacci, 134
FileNotFoundException, 288
final, 38, 205, 208, 300
flag, 79, 84
floating-point, 23, 30
flow of execution, 53, 65, 287
for, 92
 enhanced, 118
format specifier, 39, 47, 94
format string, 39, 47, 190
frame, 57, 65
functional decomposition, 297

G

garbage collection, 177, 180, 205
generalization, 165, 171
generalize, 158, 161
getter, 189, 197
GitHub, xix
Goodbye.java, 7
Google style, 8
Graphics, 273
Greenfield, Larry, 11
GuessStarter.java, 49

H

hacker, 81, 85, 154
Hand, 240
hanging, 285
hardware, 2, 12
HAS-A, 248, 249
Hello.java, 3
helper method, 219, 231
hexadecimal, 33, 40, 191

high-level language, 5, 12
histogram, 116, 122, 215
HTML, 174, 263, 268

I

IDE, 251, 261
identical, 192, 197
if statement, 72
immutable, 150, 161, 177, 208, 304
import statement, 35, 47
increment, 91, 102
incremental development, 62, 65
independent, 189
index, 103, 109, 121, 209
indexOf, 98
infinite loop, 90, 102, 285
infinite recursion, 186, 285, 286, 305
information hiding, 184, 197
inheritance, 238, 248
initialize, 19, 30, 79
inner loop, 94
InputMismatchException, 82
instance, 183, 196
instance method, 191, 195, 197
instance variable, 184, 196
instantiate, 183, 196
Integer, 151
integer division, 22, 24
interactions, 253
interpret, 5, 13
invoke, 51, 65
IS-A, 248, 249
iteration, 92, 97, 103
iterative, 127, 140

J

JAR, 252, 261
Java Tutor, 57, 140

java.awt, 167, 273
java.io, 33
java.lang, 35
java.math, 156
java.util, 34
javac, 6
Javadoc, 174, 251, 263, 268, 272
JDK, 251, 261
JFrame, 274
JVM, 6, 251, 261

K

keyword, 18, 30, 185

L

language
 elements, 36
 high-level, 5
 low-level, 5
leap of faith, 133, 141, 224
length
 array, 112
 string, 97
library, 34, 46, 173
Linux, 11
literal, 38, 47
local variable, 55, 65
logarithm, 299
Logarithm.java, 83
logic error, 29, 31, 281, 289
logical operator, 77, 84, 206
long, 59
loop, 90, 102
 for, 92
 infinite, 90
 nested, 94, 209
 search, 210
 while, 89

loop body, 90, 102
loop variable, 94, 103, 110
low-level language, 5, 12

M

magic number, 38, 47
main, 4, 52
map to, 202
Math class, 58
memory, 2, 12
memory diagram, 20, 30, 99, 112,
 147, 168, 186, 193, 204, 217
mental model, 289
merge, 223
merge sort, 221, 231
method, 4, 12
 accessor, 189
 boolean, 80
 constructor, 185
 equals, 192, 193
 getter, 189
 helper, 219
 instance, 191, 195
 modifier, 238, 303
 mutator, 190
 parameters, 55
 pure, 304
 setter, 190
 static, 195
 toString, 191
 value, 60
Mickey Mouse, 276
MissingFormatArgumentException,
 40
modifier method, 238, 303, 304
modulo, 42, 47
modulus, 43, 47
mutable, 171, 177, 180

mutator, 190

N

NaN, 85

NegativeArraySizeException, 108

nested, 288

- conditions, 75

- loops, 94

nesting, 74, 84, 209

new, 35, 49, 108, 167, 185

newline, 7, 13, 128

NewLine.java, 52

next

- Scanner, 82

nextInt

- Random, 115

- Scanner, 37

nondeterministic, 115, 122

not operator, 77

null, 149, 208

NullPointerException, 149, 154,
287

NumberFormatException, 152

O

object, 147, 161

- array of, 208

- as parameter, 169

- displaying, 191

- mutable, 171

- type, 183

Object class, 239

object code, 5, 13

object-oriented, 147, 160, 172, 248

off-by-one, 222, 231

operand, 22, 30

operator, 22, 30

- assignment, 71

- cast, 42

- logical, 77, 206

- new, 35, 49, 108, 167, 185

- redirection, 256

- relational, 71

- remainder, 42

- string, 25

or operator, 77

order of operations, 26, 30, 290

ordering, 206

outer loop, 94

overload, 186, 222, 298

overloaded, 99

overloading, 103

override, 191, 197, 249

P

package, 33, 46

paint, 274

palindrome, 145

param tag, 267

parameter, 54, 65, 169

- multiple, 55

parameter passing, 54, 65

parentheses, 26

parse, 28, 31, 152, 161

partial ordering, 206

pi, 58

Pile, 227

pixel, 275, 278

Player, 242

Point, 167

portable, 5, 13

posttest loop, 301, 302

precedence, 26, 290

pretest loop, 301, 302

primitive, 147, 161

print, 7, 191

- array, 209
- Card, 203
- print statement, 3, 12, 190, 288, 292
- printDeck, 218
- printf, 39, 101, 190
- println, 4
- PrintTime.java, 56
- PrintTwice.java, 54
- private, 174, 184, 188
- problem solving, 1, 12
- processor, 2, 12
- program, 2, 12
- programming, 3, 12
- prompt, 37, 47
- pseudocode, 219, 231
- pseudorandom, 115, 122
- public, 51
- pure method, 304

Q

- quote mark, 7, 95, 283

R

- radians, 58
- RAM, 2
- Random, 115
- randomInt, 220
- rank, 201
- rational number, 198
- Rectangle, 170
- recursion, 130, 304
 - infinite, 186, 286, 305
- recursive, 127, 140
- redirection operator, 256, 261
- reduce, 114, 116, 122
- reference, 109, 122, 168, 172, 204, 222
- relational operator, 71, 84

- remainder, 42
- replace, 150
- repository, xix
- return, 61, 83, 170
 - inside loop, 211
- return statement, 291
- return tag, 267
- return type, 60, 65
- return value, 60, 65
- RGB, 276, 278
- rounding error, 24, 30
- rubber duck, 293
- run-time error, 28, 31, 82, 209, 281

S

- scaffolding, 63, 65
- Scanner, 34
- scope, 57, 65, 175
- Scrabble, 105, 198
- search, 114, 122
- selection sort, 220, 231
- semicolon, 4, 27
- sequential search, 210, 214
- setter, 190, 197
- shadowing, 188, 197
- short circuit, 78, 84, 155
- shuffle, 219
- signature, 265, 272
- sort
 - merge, 221
 - selection, 220
- source code, 5, 13, 173
- src.zip, 173
- stack diagram, 57, 65, 129, 132, 137
- stack trace, 41, 47, 287
- StackOverflowError, 130, 186, 285, 288, 305
- state, 20, 30

- statement, 3, 12
 - assignment, 18
 - comment, 4
 - conditional, 72
 - declaration, 17, 168
 - else, 72
 - for, 92
 - if, 72
 - import, 35
 - initialization, 79
 - print, 7, 191, 288, 292
 - return, 61, 83, 170, 211, 291
 - switch, 75
 - while, 89
 - static, 185, 195, 205
 - static context, 226, 231
 - string, 7, 13
 - array of, 203
 - comparing, 100, 148
 - format, 102, 192
 - length, 97
 - operator, 25
 - reference to, 204
 - String class, 167
 - StringBuilder, 231
 - StringIndexOutOfBoundsException, 97, 155
 - stub, 63, 65
 - style guide, 8
 - subclass, 238, 248
 - subdeck, 222
 - substring, 99
 - suit, 201
 - superclass, 239, 248
 - Surprise.java, 177
 - swapCards, 220
 - switch statement, 75
 - syntax, 281
 - syntax errors, 283
 - System.err, 82, 261, 302
 - System.in, 34, 147, 256
 - System.out, 33, 147, 256
- ## T
- table, 299
 - two-dimensional, 157
 - tag, 267, 272
 - temporary variable, 61, 65, 290
 - terminal, 254
 - testing, 63, 82, 232, 255
 - text editor, 251, 261
 - this, 176, 185, 226, 236
 - Time, 184
 - addition, 194
 - toCharArray, 120
 - token, 36, 47
 - toLowerCase, 150
 - top-down design, 220, 231
 - top-down development, 243, 244
 - Torvalds, Linus, 11
 - toString, 169, 191
 - toUpperCase, 150
 - tracing, 57, 213, 258, 287
 - traversal, 113, 122
 - traverse, 210
 - type, 30
 - array, 108
 - boolean, 71, 79
 - char, 17, 95
 - double, 23
 - int, 17
 - long, 25, 59
 - object, 183
 - String, 7, 17, 167
 - void, 51
 - type cast, 42, 47

U

UML, 174, 179, 225, 248
Unicode, 96, 103
unit test, 259, 262
unreachable, 295
utility class, 34, 111

V

validate, 81, 85, 154
value, 17, 30
value constructor, 186
value method, 60
variable, 17, 29
 instance, 184

local, 55

loop, 94, 110

private, 174, 184, 188

static, 205

temporary, 61, 290

virtual machine, 6, 13, 251

void, 51, 60, 64

W

War (card game), 227

while, 89

wildcard, 257, 262

wrapper class, 151, 161

wrapper method, 231

About the Authors

Allen Downey is a Professor of Computer Science at Olin College of Engineering. He has taught computer science at Wellesley College, Colby College, and U.C. Berkeley. He has a Ph.D. in Computer Science from U.C. Berkeley and Master's and Bachelor's degrees from MIT.

Chris Mayfield is an Associate Professor of Computer Science at James Madison University, with a research focus on CS education and professional development. He has a Ph.D. in Computer Science from Purdue University and Bachelor's degrees in CS and German from the University of Utah.